



Fishing Lure Components

Parts, Precisely.





Office Hours

Monday - Thursday:
6 a.m. to 4:30 p.m. (CST)

Contact Information

Phone Numbers:

800-944-1899 or
715-344-6081

Fax Numbers:

800-374-3021 or
715-344-3021

Email Address:

sales@worthco.com

Web Site:

www.worthco.com

Shipping Address:

The Worth Company
214 Sherman Ave.
Stevens Point, WI 54481
USA

The Worth Company
is proud to be certified to
the ISO 9001:2015 standard
for manufacturing.



Table of Contents

BEADS

Fluorescent Plastic Beads.....	101-103
Hollow Metal Beads	100
Solid Brass Beads.....	99

CLAMSHELLS	113-114
-------------------------	---------

CLEVISES

Clip-N-Spin Clevis	91
Double Clevis	92
Easy-Spin Clevises	88
Folded Clevises.....	90
Strip Clevis	89

CUSTOM COLORS & PAINT	115-119
--	---------

CUSTOM MANUFACTURING	120-121
-----------------------------------	---------

LURE BODIES	97-98
--------------------------	-------

SPINNERBLADES

Buzzer Blades	84-85
Colorado	25-29
Colorado - Aspen	33-37
Colorado - Aspen - Steel	38
Colorado - Aspen - Deep Cup	39-41
Colorado - Badger	30
Colorado - Steel	31-32
Fluted Blades	57-58
French Blades	53-56
Ice Blades.....	42
Indiana	43-47
Indiana - Badger	48
Indiana - Steel	49-50
Inline Blades	21-22
June Bug Blades.....	23
Magnum Blades	51-52
Olympic Blades.....	79-83
Propeller Blades	86
Ripple Blades	24
Roto Blades.....	20
Swing Blades.....	77-78
TurboProp Blades.....	87
Whiptail Blades	75-76
Willowleaf	59-63
Willowleaf - Aspen.....	67-69
Willowleaf - Aspen Steel.....	70
Willowleaf Shallow Cup	71-72
Willowleaf Serrated Blades.....	73-74
Willowleaf - Steel	65-66

SPLIT RINGS

Fine Gauge Split Rings	7-8
Heavyweight Split Rings	4
Oval Rings	3
Split Ring Qualities	2
Standard Gauge Split Rings	5-6

SPOONS

Casting Spoons Brass	11-14
Casting Spoons Steel	9-10
Trolling Spoons	15-18

SWIVELS

Ball Bearing Swivels	94
Barrel Swivels.....	95

TERMS & INFORMATION	122
--------------------------------------	-----

TOOLS

Fly Tying Vise	111
Industrial Wire Former	109
Split Ring Pliers	112
Wire Forming Tool.....	110

WIRE FORMS & MISC

Coil Spring Fasteners	105
Disc Washers	93
Figure 8 Hook Hangers	104
Red Flipper	96
Straight Wire Shafts	106
Trolling Rig Rudder	19
Wire Shafts Type A	107
Wire Shafts Type B	108



Split Ring Qualities

Which Split Ring is the Right Ring for You?

We have devised two charts that help answer some important questions when you are deciding on which split ring will be perfect for you.

Chart A

Allows you to choose a ring based on the feature most important to your application.

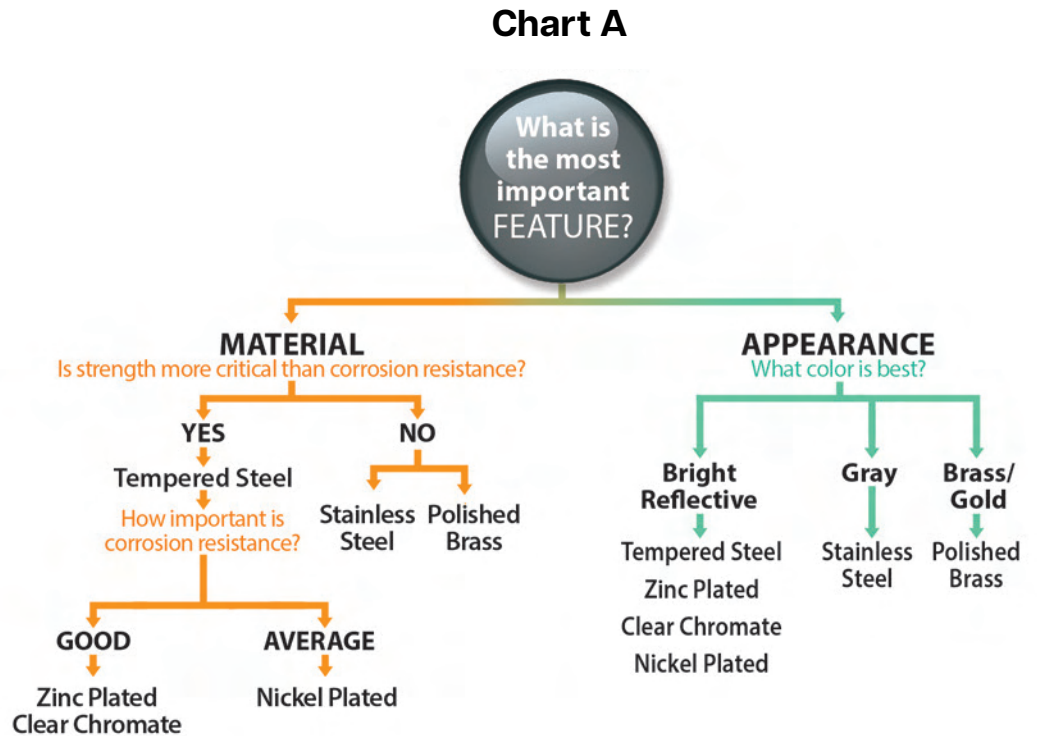

Chart B

Gives you more detailed information about materials, their finishes and availability.

If you have any questions about our finishes, standard or custom, or specific proper ties of the materials we use in our split rings, please call. Our staff knows split rings and will be happy to assist you in choosing the right split ring for you.

Chart B

Tempered Steel

Standard Finishes	Availability	Appearance	Corrosion Resistance	Strength/Memory
Plain Polished				
Nickel Plated	X	Bright Reflective	Average	Very High
Clear Chromate over Zinc	X	Bright/Blue Hue	Moderate High	Very High

Stainless Steel

Standard Finishes	Availability	Appearance	Corrosion Resistance	Strength/Memory
Plain Polished	X	Bright Gray	Very High	Average
Nickel Plated				
Clear Chromate over Zinc				

Brass

Standard Finishes	Availability	Appearance	Corrosion Resistance	Strength/Memory
Plain Polished	X	Gold	Very High	Marginal
Nickel Plated	X	Bright Reflective	Very High	Marginal
Clear Chromate over Zinc				



Split Rings - Oval

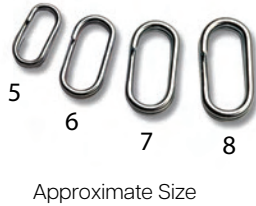
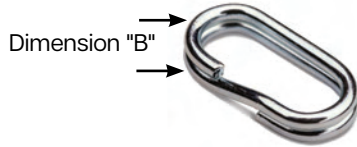

- 50% stronger than similar fine sized round split rings.
- Self-centering to keep the "cutoff" at the side.
- High quality materials
- Superior zinc plating for corrosion protection.

Oval Split Rings

Size	5	6	7	8
Length	.315 in / 8 mm	.394 in / 10 mm	.433 in / 11 mm	.472 in / 12 mm
Width	.158 in / 4 mm	.197 in / 5 mm	.217 in / 5.5 mm	.236 in / 6 mm
"B" Dimension	.059 in / 1.50 mm	.065 in / 1.65 mm	.073 in / 1.85 mm	.080 in / 2.03 mm
Wire Diameter	.028	.032	.036	.040
Weight Per Thousand	.23 lb / .104 kg	.37 lb / .168 kg	.54 lb / .245 kg	.72 lb / .327 kg
Zinc Plated Steel	82105	82106	82107	82108
See Website for Pricing				

Packaging: Bulk, Polybagged

Quantity Discounts (per size & finish) 5M-9M less 5%, 10M-24M less 10%, 25M-49M less 15%, 50M-99M less 20%
100M-499M less 25%, 500M-999M less 30%, 1MM-Over less 35%



WARNING: This product can expose you to chemicals including nickel and lead, which are known to the State of California to cause cancer and birth defects or other reproductive harm. For more information, visit www.P65Warnings.ca.gov



Split Rings - Heavy

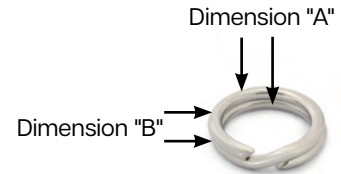

O.D. Tolerances:
Steel and Stainless Steel + .015" - .005"

- Made for high strength applications
- Made from heavy gauge spring tempered steel & stainless steel
- Ideal for large game fish such as musky and pike
- Stainless steel recommended for saltwater applications

Heavy Weight Split Rings

Size	4	5	6	7
Outside Diameter	.292 in / 7.42 mm	.334 in / 8.48 mm	.380 in / 9.65 mm	.430 in / 10.92 mm
Approx. Inside Dia.	.200 in / 5.08 mm	.232 in / 5.89 mm	.278 in / 7.06 mm	.316 in / 8.03 mm
Approx. "A" Dim.	.046 in / 1.17 mm	.051 in / 1.30 mm	.051 in / 1.30 mm	.057 in / 1.45 mm
At "B" +/- .005in./1.3mm	.068 in / 1.73 mm	.074 in / 1.88 mm	.074 in / 1.88 mm	.083 in / 2.11 mm
Wire Diameter	.040	.045	.045	.051
Weight Per Thousand	.54 lb / .24 kg	.79 lb / .37 kg	.92 lb / .43 kg	1.34 lb / .63 kg
Nickel-Plated Steel	94244	94245	94246	94247
See Website for Pricing				
Stainless Steel	91604	91605	91606	91607
See Website for Pricing				
Zinc Plated Steel	94274	94275	94276	94277
See Website for Pricing				

Packaging: Bulk, Polybagged

Quantity Discounts (per size & finish) 5M-9M less 5%, 10M-24M less 10%, 25M-49M less 15%, 50M-99M less 20%
100M-499M less 25%, 500M-999M less 30%, 1MM-Over less 35%



WARNING: This product can expose you to chemicals including nickel and lead, which are known to the State of California to cause cancer and birth defects or other reproductive harm. For more information, visit www.P65Warnings.ca.gov



Split Rings - Standard

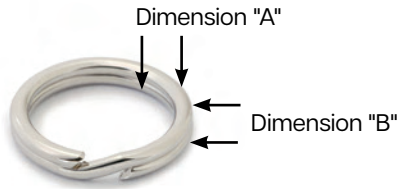

O.D. Tolerances:
 Steel and Stainless Steel + .015" - .005"
 Brass + .025" - .005"

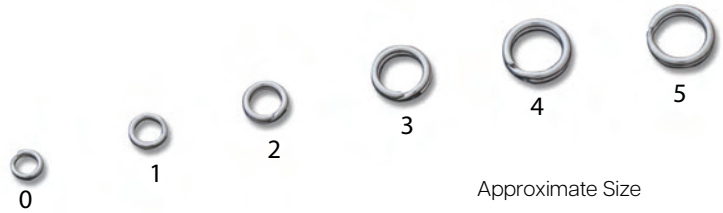

- Made in the USA
- The standard in the fishing tackle industry
- Unmatched quality
- Used in aerospace, automotive, and defense industries.

Standard Gauge Split Rings

Size	0	1	2	3	4	5
Outside Diameter	.165 in / 4.19 mm	.190 in / 4.83 mm	.220 in / 5.59 mm	.254 in / 6.45 mm	.292 in / 7.42 mm	.334 in / 8.48 mm
Approx. Inside Dia.	.107 in / 2.72 mm	.128 in / 3.25 mm	.150 in / 3.81 mm	.174 in / 4.42 mm	.212 in / 5.39 mm	.242 in / 6.15 mm
Approx. "A" Dim.	.029 in / .74 mm	.031 in / .79 mm	.035 in / .89 mm	.040 in / 1.02 mm	.040 in / 1.02 mm	.046 in / 1.17 mm
At "B" +/- .005 in/.13mm	.040 in / 1.02 mm	.046 in / 1.17 mm	.054 in / 1.37 mm	.062 in / 1.58 mm	.062 in / 1.58 mm	.068 in / 1.73 mm
Wire Diameter	.025	.028	.032	.036	.036	.040
Weight Per Thousand	.13 lb / .054 kg	.18 lb / .077 kg	.28 lb / .118 kg	.41 lb / .172 kg	.48 lb / .204 kg	.68 lb / .290 kg
Nickel-Plated Brass	92100	92101	92102	92103	92104	92105
See Website for Pricing						
Polished Brass	92400	92401	92402	92403	92404	92405
See Website for Pricing						
Stainless Steel	--	--	94212	94213	94214	94215
See Website for Pricing	--	--				
Nickel-Plated Steel	92000	92001	92002	92003	92004	92005
See Website for Pricing						
Zinc Plated Steel	92200	92201	92202	92203	92204	92205
See Website for Pricing						

Packaging: Bulk, Polybagged

Quantity Discounts (per size & finish) 5M-9M less 5%, 10M-24M less 10%, 25M-49M less 15%, 50M-99M less 20%, 100M-499M less 25%, 500M-999M less 30%, 1MM-Over less 35%



WARNING: This product can expose you to chemicals including nickel and lead, which are known to the State of California to cause cancer and birth defects or other reproductive harm. For more information, visit www.P65Warnings.ca.gov



Split Rings - Standard

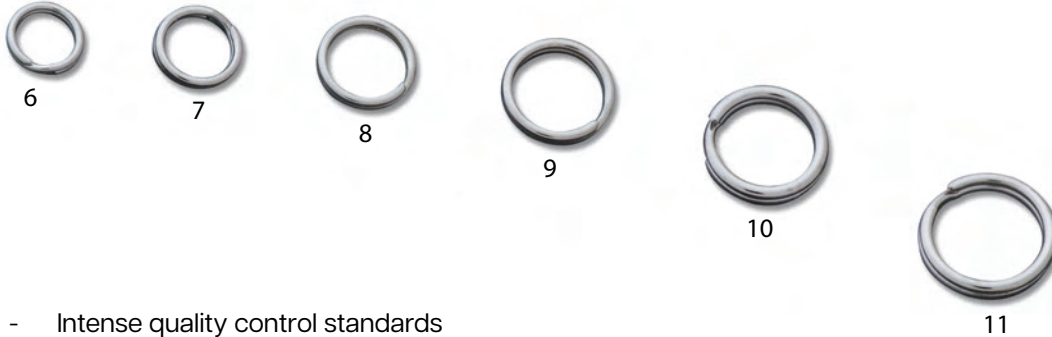

- Intense quality control standards
- Available in brass, stainless steel, and spring-tempered steel
- Perfect for every fishing application
- Finest quality rings available anywhere.

Choose the "Right" Ring

		Good	Better	Best
Stainless Steel	Strength		X	
	Price			X
	Memory		X	
	Corrosion Resistance			X
Nickel	Strength			X
	Price		X	
	Memory			X
	Corrosion Resistance	X		
Zinc	Strength			X
	Price		X	
	Memory			X
	Corrosion Resistance		X	

Standard Gauge Split Rings

Size	6	7	8	9	10	11
Outside Diameter	.380 in / 9.65 mm	.43 in / 10.92 mm	.484 in / 12.29 mm	.542 in / 13.77 mm	.604 in / 15.34 mm	.670 in / 17.02 mm
Approx. Inside Dia.	.288 in / 7.32 mm	.328 in / 8.33 mm	.382 in / 9.70 mm	.428 in / 10.87 mm	.460 in / 11.68 mm	.526 in / 13.36 mm
Approx. "A" Dim.	.046 in / 1.17 mm	.051 in / 1.30 mm	.051 in / 1.30 mm	.057 in / 1.45 mm	.072 in / 1.83 mm	.072 in / 1.83 mm
At "B" +/- .005in/.13mm	.068 in / 1.73 mm	.074 in / 1.88 mm	.074 in / 1.88 mm	.083 in / 2.11 mm	.105 in / 2.67 mm	.105 in / 2.67 mm
Wire Diameter	.040	.045	.045	.051	.064	.064
Weight Per Thousand	.78 lb / .336 kg	1.12 lb / .481 kg	1.30 lb / .549 kg	1.84 lb / .789 kg	3.18 lb / 1.365 kg	3.57 lb / 1.533 kg
Nickel-Plated Brass	92106	92107	92108	92109	92110	92111
See Website for Pricing						
Polished Brass	92406	92407	92408	92409	92410	92411
See Website for Pricing						
Stainless Steel	94216	94217	94218	94219	94220	94221
See Website for Pricing						
Nickel-Plated Steel	92006	92007	92008	92009	92010	92011
See Website for Pricing						
Zinc Plated Steel	92206	92207	92208	92209	92210	92211
See Website for Pricing						

Packaging: Bulk, Polybagged

Quantity Discounts (per size & finish) 5M-9M less 5%, 10M-24M less 10%, 25M-49M less 15%, 50M-99M less 20%, 100M-499M less 25%, 500M-999M less 30%, 1MM-Over less 35%



WARNING: This product can expose you to chemicals including nickel and lead, which are known to the State of California to cause cancer and birth defects or other reproductive harm. For more information, visit www.P65Warnings.ca.gov



Split Rings - Fine

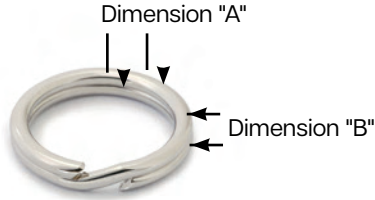

O.D. Tolerances:
 Steel and Stainless Steel +.015" - .005"
 Brass +.025" - .005"

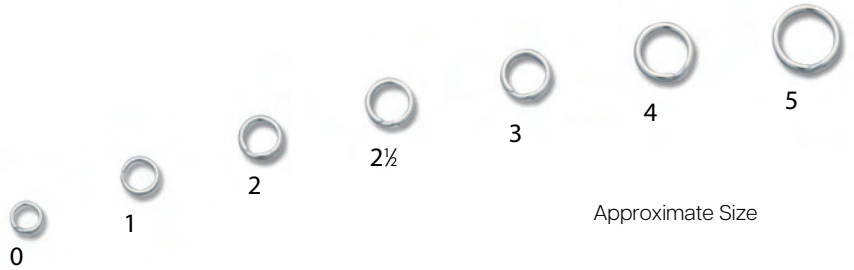

- Same intense quality standards as all Worth split rings
- Made from finer gauge wire for lighter applications
- Easy to assemble

Fine Gauge Split Rings

* = Brass & Steel "B" Dimension is .034"
 ** = Brass & Steel Wire is .020"

Size	0	1	2	2½	3	4	5
Outside Diameter	.165 in / 4.19 mm	.190 in / 4.83 mm	.220 in / 5.59 mm	.237 in / 6.02 mm	.254 in / 6.45 mm	.292 in / 7.42 mm	.334 in / 8.48 mm
Approx. Inside Dia.	.117 in / 2.97 mm	.142 in / 3.61 mm	.162 in / 4.12 mm	.179 in / 4.55 mm	.192 in / 4.88 mm	.222 in / 5.64 mm	.264 in / 6.71 mm
Approx. "A" Dim.	.024 in / .61 mm	.024 in / .61 mm	.029 in / .74 mm	.029 in / .74 mm	.031 in / .79 mm	.035 in / .89 mm	.035 in / .89 mm
At "B" +/- .005in/.13mm	.034 in / .86 mm	.036 in / .91 mm*	.040 in / 1.02 mm	.036 in / 1.02 mm	.046 in / 1.17 mm	.054 in / 1.37 mm	.054 in / 1.37 mm
Wire Diameter	.020	.022**	.025	.022	.028	.032	.032
Weight Per Thousand	.09 lb / .036 kg	.10 lb / .041 kg	.18 lb / .077 kg	.15 lb / .064 kg	.26 lb / .109 kg	.38 lb / .163 kg	.45 lb / .191 kg
Nickel-Plated Brass	92600	92601	92602	--	92603	92604	92605
See Website for Pricing							
Polished Brass	92900	92901	92902	--	92903	92904	92905
See Website for Pricing							
Stainless Steel	94550	94551	94552	94563	94553	94554	94555
See Website for Pricing							
Nickel-Plated Steel	92500	92501	92502	92513	92503	92504	92505
See Website for Pricing							
Zinc Plated Steel	92700	92701	92702	92713	92703	92704	92705
See Website for Pricing							

Packaging: Bulk, Polybagged

Quantity Discounts (per size & finish) 5M-9M less 5%, 10M-24M less 10%, 25M-49M less 15%, 50M-99M less 20%, 100M-499M less 25%, 500M-999M less 30%, 1MM-Over less 35%



WARNING: This product can expose you to chemicals including nickel and lead, which are known to the State of California to cause cancer and birth defects or other reproductive harm. For more information, visit www.P65Warnings.ca.gov



Split Rings - Fine

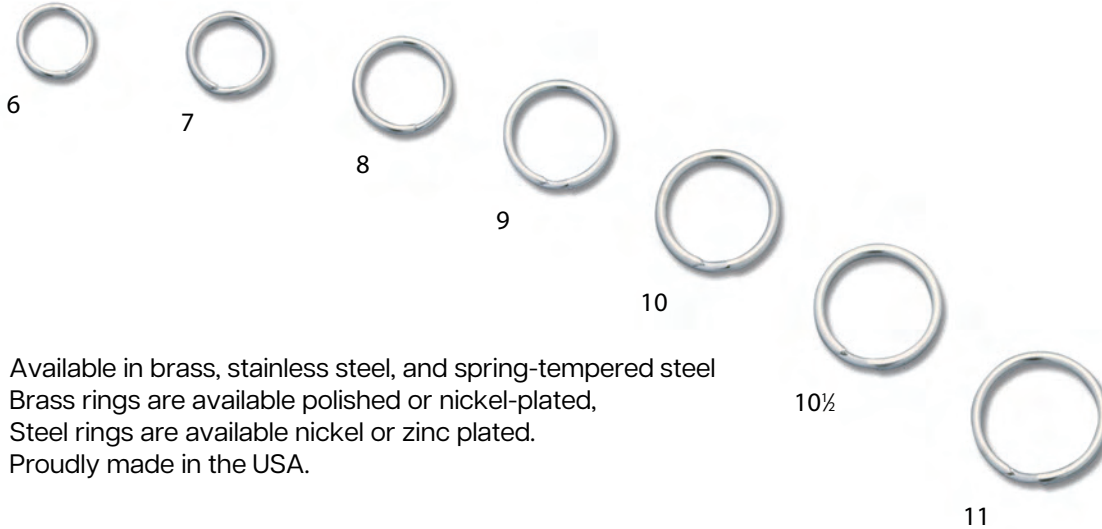

- Available in brass, stainless steel, and spring-tempered steel
- Brass rings are available polished or nickel-plated,
- Steel rings are available nickel or zinc plated.
- Proudly made in the USA.

Choose the "Right" Ring

	Good	Better	Best
Stainless Steel	Strength		X
	Price		X
	Memory	X	
	Corrosion Resistance		X
Nickel	Strength		X
	Price	X	
	Memory		X
	Corrosion Resistance	X	
Zinc	Strength		X
	Price	X	
	Memory		X
	Corrosion Resistance	X	

Fine Gauge Split Rings

Size	6	7	8	9	10	10½	11
Outside Diameter	.38 in / 9.65 mm	.43 in / 10.92 mm	.484 in / 12.29 mm	.542 in / 13.77 mm	.604 in / 15.34 mm	.630 in / 16.0 mm	.670 in / 17.02 mm
Approx. Inside Dia.	.30 in / 7.62 mm	.338 in / 8.59 mm	.392 in / 9.96 mm	.440 in / 11.18 mm	.49 in / 12.45 mm	.516 in / 13.11 mm	.556 in / 14.12 mm
Approx. "A" Dim.	.04 in / 1.02 mm	.046 in / 1.17 mm	.046 in / 1.17 mm	.051 in / 1.30 mm	.057 in / 1.45 mm	.057 in / 1.45 mm	.057 in / 1.45 mm
At "B" +/- .005in/.13mm	.062 in / 1.58 mm	.068 in / 1.73 mm	.068 in / 1.73 mm	.074 in / 1.88 mm	.083 in / 2.11 mm	.083 in / 2.11 mm	.083 in / 2.11 mm
Wire Diameter	.036	.040	.040	.045	.051	.051	.051
Weight Per Thousand	.64 lb / .277 kg	.90 lb / .386 kg	1.02 lb / .440 kg	1.45 lb / .621 kg	2.07 lb / .889 kg	2.00 lb / .910 kg	2.32 lb / .993 kg
Nickel-Plated Brass	92606	92607	92608	92609	92610	--	92611
See Website for Pricing							
Polished Brass	92906	92907	92908	92909	92910	--	92911
See Website for Pricing							
Stainless Steel	94556	94557	94558	94559	94560	--	94561
See Website for Pricing							
Nickel-Plated Steel	92506	92507	92508	92509	92510	92525	92511
See Website for Pricing							
Zinc Plated Steel	92706	92707	92708	92709	92710	--	92711
See Website for Pricing							

Packaging: Bulk, Polybagged

Quantity Discounts (per size & finish) 5M-9M less 5%, 10M-24M less 10%, 25M-49M less 15%, 50M-99M less 20%, 100M-499M less 25%, 500M-999M less 30%, 1MM-Over less 35%



WARNING: This product can expose you to chemicals including nickel and lead, which are known to the State of California to cause cancer and birth defects or other reproductive harm. For more information, visit www.P65Warnings.ca.gov



Casting Spoons - Steel



3 1/2"



2 7/8"



2 1/4"



1 3/4"

Approximate Size

- Irresistible wobbling action
- Ideal for countless species
- Multiple sizes and weight options
- Highest flash and visibility
- Classic spoon shape & design

Steel Casting Spoons - Smooth

Size	1 3/4	2 1/4	2 7/8	3 1/2
Gauge	.045	.045	.045	.045
Length (in.)	1.738	2.192	2.825	3.485
Width (in.)	.674	.828	1.052	1.110
Approx. Hole Diameter (in.)	.116	.118	.120	.124
Weight Per Thousand (lbs.)	11.85	17.97	30.09	39.73
Nickel	93405	93404	93403	93402
See Website for Pricing				

Packaging: Bulk, Polybagged

Quantity Discounts (per size & finish) 5M-9M less 5%, 10M-24M less 10%, 25M-49M less 15%, 50M-99M less 20% 100M-Over less 25%



WARNING: This product can expose you to chemicals including nickel and lead, which are known to the State of California to cause cancer and birth defects or other reproductive harm. For more information, visit www.P65Warnings.ca.gov



Casting Spoons - Steel

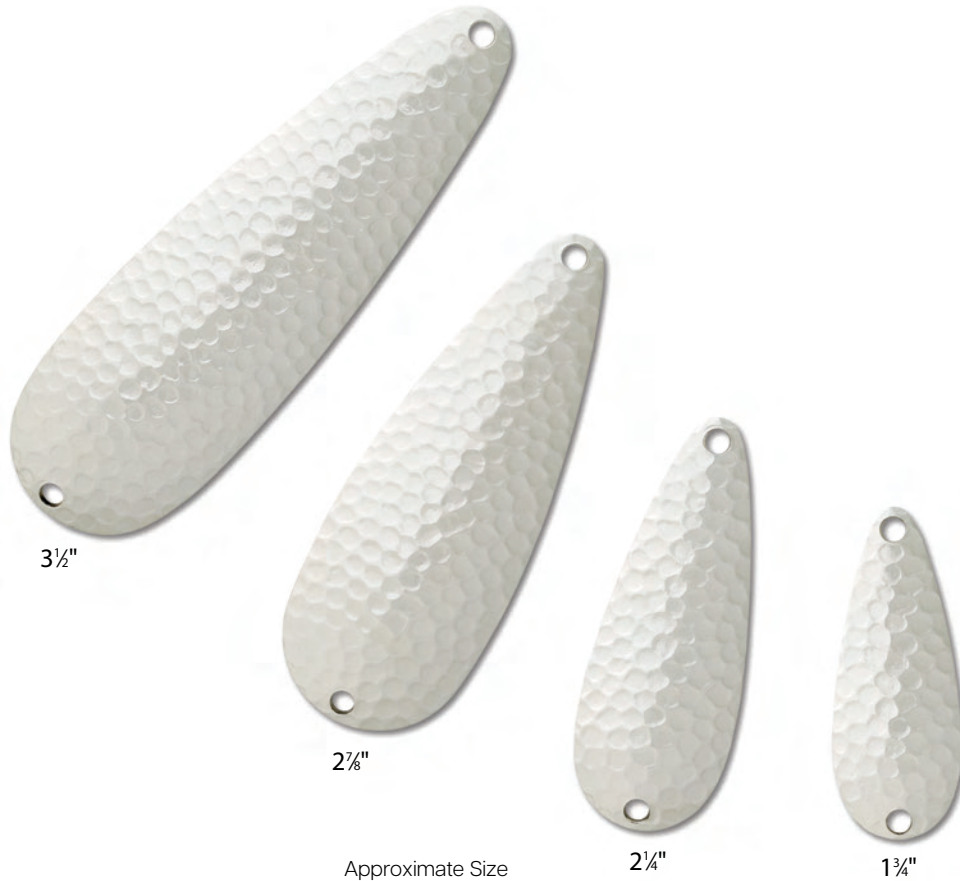

Steel Casting Spoons - Hammered

Size	1 3/4	2 1/4	2 7/8	3 1/2
Gauge	.045	.045	.045	.045
Length (in.)	1.738	2.192	2.825	3.485
Width (in.)	.674	.828	1.052	1.110
Hole Diameter (in.)	.118	.119	.121	.125
Weight Per Thousand (lbs.)	10.91	17.14	25.79	38.03
Nickeled	93425	93424	93423	93422
See Website for Pricing				

Packaging: Bulk, Polybagged

Quantity Discounts (per size & finish) 5M-9M less 5%, 10M-24M less 10%, 25M-49M less 15%, 50M-99M less 20% 100M-Over less 25%



WARNING: This product can expose you to chemicals including nickel and lead, which are known to the State of California to cause cancer and birth defects or other reproductive harm. For more information, visit www.P65Warnings.ca.gov



Casting Spoons

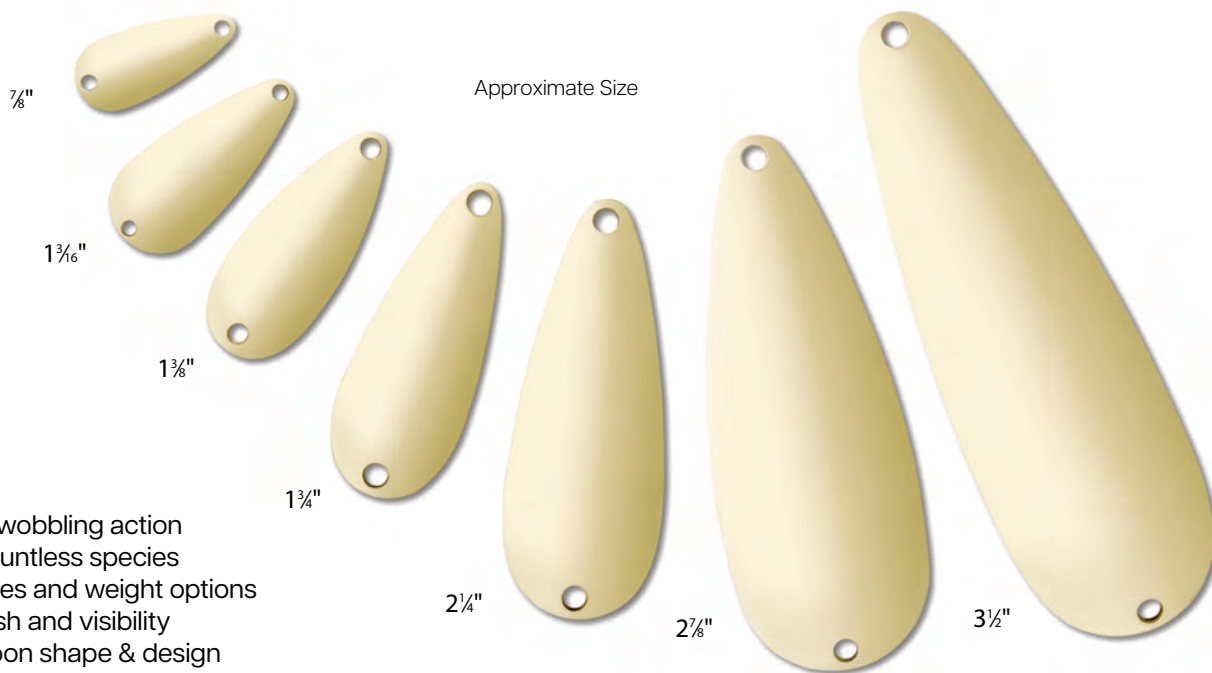

- Irresistible wobbling action
- Ideal for countless species
- Multiple sizes and weight options
- Highest flash and visibility
- Classic spoon shape & design

Brass Casting Spoons - Smooth

Size	7/8	1 3/16	1 3/16	1 3/8	1 3/8	1 3/4	2 1/4	2 7/8	3 1/2	3 1/2
Gauge	.025	.018	.045	.018	.045	.045	.045	.045	.018	.045
Length (in.)	.890	1.178	1.178	1.379	1.379	1.738	2.192	2.825	3.485	3.485
Width (in.)	.386	.526	.526	.565	.565	.674	.828	1.064	1.110	1.110
Hole Diameter (in.)	.071	.075	.072	.099	.096	.117	.119	.121	.123	.124
Weight Per Thousand (lbs.)	2.04	2.65	6.56	3.31	8.43	12.35	19.40	32.74	17.30	43.37
Plain Brass	93014	93016	93065	93015	93055	93045	93004	93003	93001	93002
Call for Pricing										
Polished Brass	93114	93116	93165	93115	93155	93145	93104	93103	93101	93102
See Website for Pricing										
Nickel	93214	93216	93265	93215	93255	93245	93204	93203	93201	93202
See Website for Pricing										
Gold Plate	93314	93316	93365	93315	93355	93345	93304	93303	93301	93302
Call for Pricing										

Packaging: Bulk, Polybagged

Quantity Discounts (per size & finish) 5M-9M less 5%, 10M-24M less 10%, 25M-49M less 15%, 50M-99M less 20% 100M-Over less 25% **Discounts not available on gold.**



WARNING: This product can expose you to chemicals including nickel and lead, which are known to the State of California to cause cancer and birth defects or other reproductive harm. For more information, visit www.P65Warnings.ca.gov

www.worthco.com sales@worthco.com



Casting Spoons

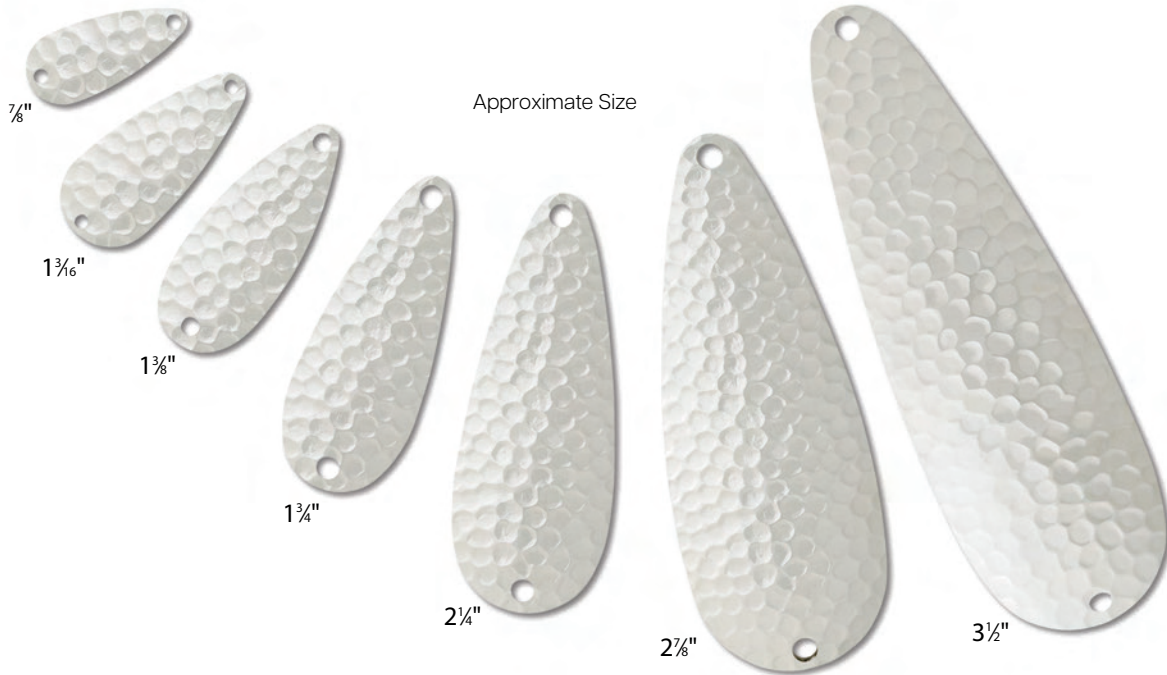

Brass Casting Spoons - Hammered

Size	7/8	1 3/16	1 3/8	1 3/4	2 1/4	2 7/8	3 1/2		
Gauge	.025	.018	.045	.018	.045	.045	.045	.045	
Length (in.)	.890	1.178	1.178	1.379	1.379	1.738	2.192	2.825	3.485
Width (in.)	.386	.526	.526	.565	.565	.674	.828	1.064	1.110
Hole Diameter (in.)	.076	.076	.070	.098	.097	.118	.119	.121	.124
Weight Per Thousand (lbs.)	1.82	2.26	6.23	2.98	7.77	11.74	18.02	31.41	41.72
Plain Brass	93064	93036	93027	93035	93026	93025	93024	93023	93022
Call for Pricing									
Polished Brass	93164	93136	93127	93135	93126	93125	93124	93123	93122
See Website for Pricing									
Nickel	93264	93236	93227	93235	93226	93225	93224	93223	93222
See Website for Pricing									
Gold Plate	93364	93336	93327	93335	93326	93325	93324	93323	93322
Call for Pricing									

Packaging: Bulk, Polybagged

Quantity Discounts (per size & finish) 5M-9M less 5%, 10M-24M less 10%, 25M-49M less 15%, 50M-99M less 20% 100M-Over less 25% **Discounts not available on gold**



WARNING: This product can expose you to chemicals including nickel and lead, which are known to the State of California to cause cancer and birth defects or other reproductive harm. For more information, visit www.P65Warnings.ca.gov



Casting Spoons

Approximate Size



Brass Casting Spoons - Hex

Size	2 1/4"	2 7/8"
Gauge	.045	.045
Length (in.)	2.192	2.83
Width (in.)	.828	1.045
Hole Diameter (in.)	.125	.128
Weight Per Thousand (lbs.)	19.40	32.74
Plain Brass	93074	93073
Call for Pricing		
Polished Brass	93484	93483
See Website for Pricing		
Nickeled	93474	93473
See Website for Pricing		

Packaging: Bulk, Polybagged

Quantity Discounts (per size & finish)

5M-9M less 5%, 10M-24M less 10%, 25M-49M less 15%, 50M-99M less 20%, 100M-Over less 25% **Discounts not available on gold.**



WARNING: This product can expose you to chemicals including nickel and lead, which are known to the State of California to cause cancer and birth defects or other reproductive harm. For more information, visit www.P65Warnings.ca.gov



Casting Spoons

Painted Items

See our Custom Colors section starting on **page 115** for information on painted items



Brass Casting Spoons - Painted One Side

Size	1 3/16	1 3/8	1 3/8	1 3/8	1 3/4	2 1/4	2 7/8	3 1/2	3 1/2
Gauge	.018	.045	.018	.045	.045	.045	.045	.018	.045
Product Number	7DC01	7EC01	7DE01	7EE01	7ED01	7EH01	7EI01	7DJ01	7EJ01
Call for Pricing									

Brass Casting Spoons - Painted Two Sides

Size	1 3/16	1 3/8	1 3/8	1 3/8	1 3/4	2 1/4	2 7/8	3 1/2	3 1/2
Gauge	.018	.045	.018	.045	.045	.045	.045	.018	.045
Product Number	7DC02	7EC02	7DE02	7EE02	7ED02	7EH02	7EI02	7DJ02	7EJ02
Call for Pricing									

Note: All painted blades are brass material.

Prices stated refer to smooth blades and apply to orders of 1,000 pieces (per size and finish)

Painted blades are not stock items. Please allow 2-3 weeks for delivery.



WARNING: This product can expose you to chemicals including nickel and lead, which are known to the State of California to cause cancer and birth defects or other reproductive harm. For more information, visit www.P65Warnings.ca.gov



Trolling Spoons

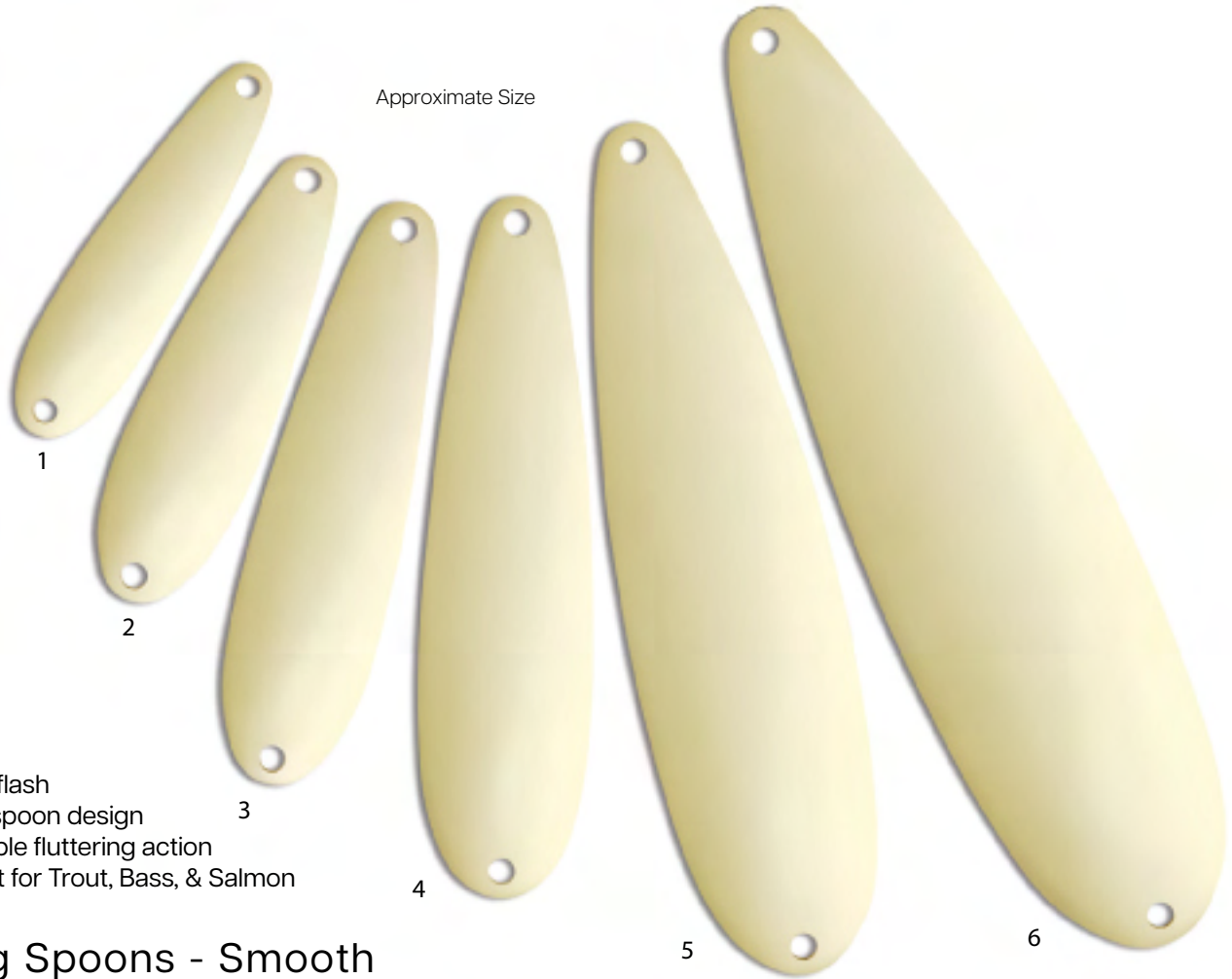

- Highest flash
- Classic spoon design
- Irresistible fluttering action
- Excellent for Trout, Bass, & Salmon

Trolling Spoons - Smooth

Size	1	2	3	4	5	6
Length (in.)	2.330	2.593	3.224	3.780	4.688	5.489
Width (in.)	.580	.730	.803	.936	1.181	1.388
Hole Diameter (in.)	.121	.136	.135	.137	.133	.137
Thickness (in.)	.025	.025	.025	.025	.025	.025
Weight Per Thousand (lbs.)	8.54	12.01	16.26	22.15	33.78	50.81
Plain Brass	93911	93912	93913	93914	93915	93916
Call for Pricing						
Polished Brass	93921	93922	93923	93924	93925	93926
See Website for Pricing						
Nickeled	93931	93932	93933	93934	93935	93936
See Website for Pricing						
Gold Plate	93971	93972	93973	93974	93975	93976
Call for Pricing						

Packaging: Bulk, Polybagged

Quantity Discounts (per size & finish) 5M-9M less 5%, 10M-24M less 10%, 25M-49M less 15%, 50M-99M less 20% 100M-Over less 25% **Discounts not available on gold**



WARNING: This product can expose you to chemicals including nickel and lead, which are known to the State of California to cause cancer and birth defects or other reproductive harm. For more information, visit www.P65Warnings.ca.gov



Trolling Spoons

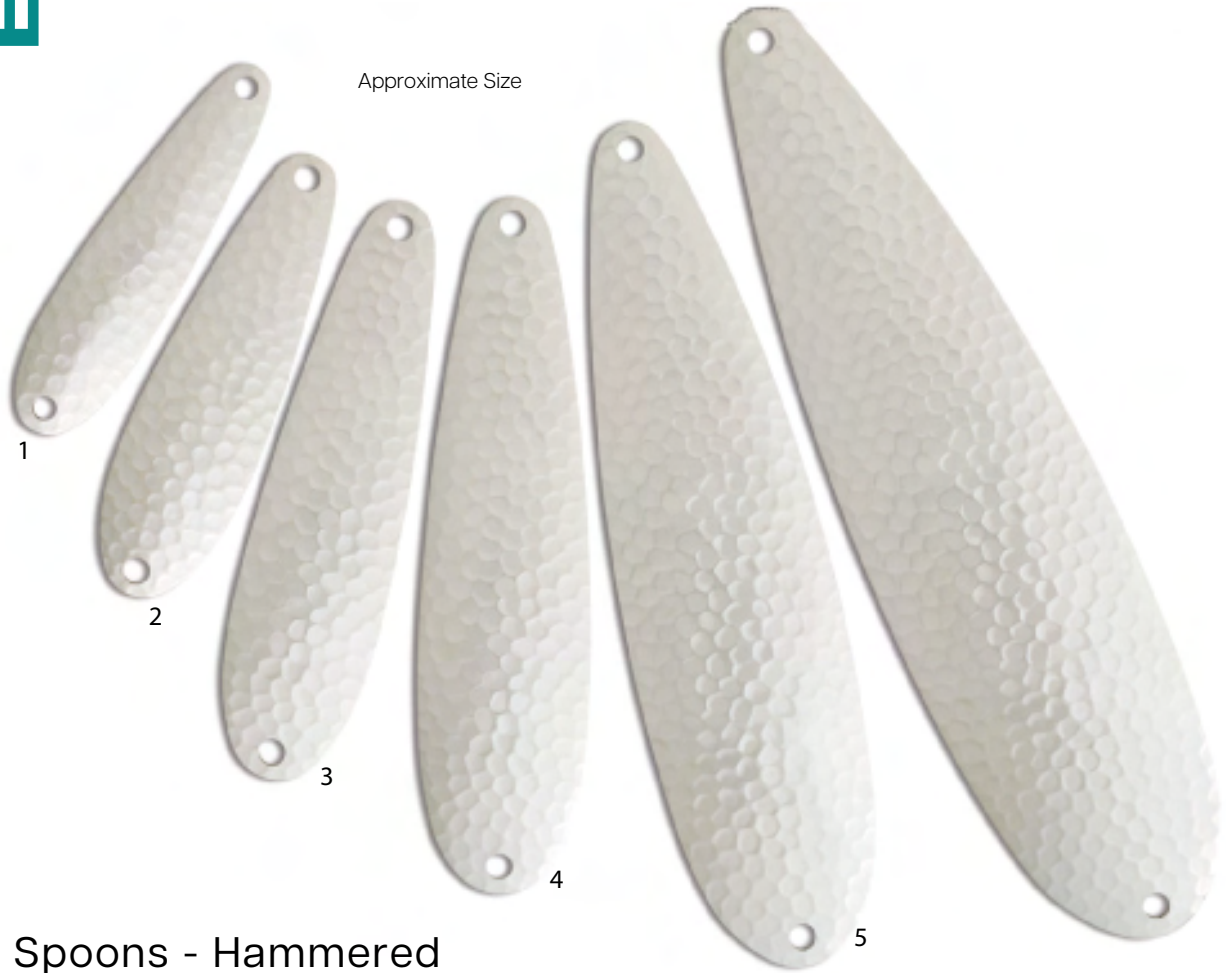

Trolling Spoons - Hammered

Size	1	2	3	4	5	6
Length (in.)	2.330	2.593	3.224	3.780	4.688	5.489
Width (in.)	.580	.730	.803	.936	1.185	1.388
Hole Diameter (in.)	.121	.137	.137	.137	.135	.137
Thickness (in.)	.025	.025	.025	.025	.025	.025
Weight Per Thousand (lbs.)	7.99	10.80	15.16	20.17	32.46	44.25
Plain Brass	93941	93942	93943	93944	93945	93946
Call for Pricing						
Polished Brass	93951	93952	93953	93954	93955	93956
See Website for Pricing						
Nickeled	93961	93962	93963	93964	93965	93966
See Website for Pricing						
Gold Plate	93981	93982	93983	93984	93985	93986
Call for Pricing						

Packaging: Bulk, Polybagged

Quantity Discounts (per size & finish) 5M-9M less 5%, 10M-24M less 10%, 25M-49M less 15%, 50M-99M less 20% 100M-Over less 25% **Discounts not available on gold**



WARNING: This product can expose you to chemicals including nickel and lead, which are known to the State of California to cause cancer and birth defects or other reproductive harm. For more information, visit www.P65Warnings.ca.gov

www.worthco.com

sales@worthco.com



Trolling Spoons

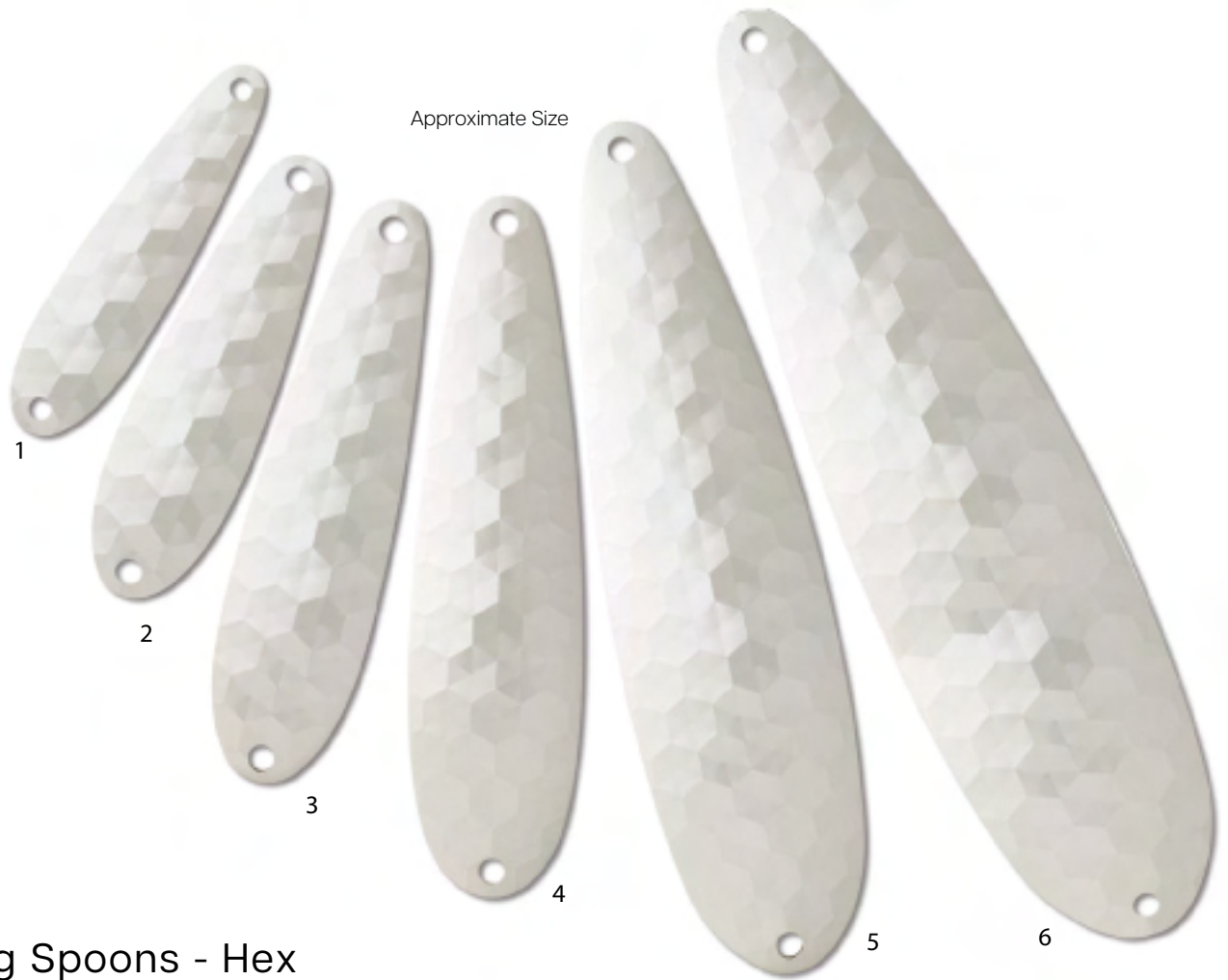

Trolling Spoons - Hex

Size	1	2	3	4	5	6
Length (in.)	2.330	2.593	3.224	3.780	4.688	5.489
Width (in.)	.580	.730	.803	.936	1.183	1.388
Hole Diameter (in.)	.121	.137	.136	.137	.135	.137
Thickness (in.)	.025	.025	.025	.025	.025	.025
Weight Per Thousand (lbs.)	7.99	10.80	16.14	21.88	34.60	44.25
Plain Brass	83941	83942	83943	83944	83945	83946
Call for Pricing						
Polished Brass	83951	83952	83953	83954	83955	83956
See Website for Pricing						
Nickeled	83961	83962	83963	83964	83965	83966
See Website for Pricing						
Gold Plate	83981	83982	83983	83984	83985	83986
Call for Pricing						

Packaging: Bulk, Polybagged

Quantity Discounts (per size & finish) 5M-9M less 5%, 10M-24M less 10%, 25M-49M less 15%, 50M-99M less 20% 100M-Over less 25% **Discounts not available on gold**



WARNING: This product can expose you to chemicals including nickel and lead, which are known to the State of California to cause cancer and birth defects or other reproductive harm. For more information, visit www.P65Warnings.ca.gov

www.worthco.com

sales@worthco.com



Trolling Spoons

Painted Items

See our Custom Colors section starting on **page 115** for information on painted items



Trolling Smooth Spoons - Painted One Side

Size	1	2	3	4	5	6
Product Number	7K101	7K201	7K301	7K401	7K501	7K601
Call for Pricing						

Trolling Smooth Spoons - Painted Two Sides

Size	1	2	3	4	5	6
Product Number	7K102	7K202	7K302	7K402	7K502	7K602
Call for Pricing						

Note: All painted blades are brass material.

Prices stated refer to smooth blades and apply to orders of 1,000 pieces (per size and finish).

Painted blades are not stock items. Please allow 2-3 weeks for delivery.



WARNING: This product can expose you to chemicals including nickel and lead, which are known to the State of California to cause cancer and birth defects or other reproductive harm. For more information, visit www.P65Warnings.ca.gov



Trolling Rig Rudder



- Precision stamped from high grade brass
- Two 1/8" holes at the top
- Used extensively for trolls or cowbells

Trolling Rig Rudder

Size	1 1/2" x 1 1/8"
Gauge	.025
Hole Diameter (in.)	.123
Thickness (in.)	.025
Weight Per Thousand (lbs.)	12.95
Plain Brass	95902
Call for Pricing	
Polished Brass	95912
See Website for Pricing	
Nickeled	95922
See Website for Pricing	

Packaging: Bulk, Polybagged

Quantity Discounts (per size & finish) 5M-9M less 5%,
10M-24M less 10%, 25M-49M less 15%, 50M-99M less 20%,
100M-Over less 25%



WARNING: This product can expose you to chemicals including nickel and lead, which are known to the State of California to cause cancer and birth defects or other reproductive harm. For more information, visit www.P65Warnings.ca.gov



Roto

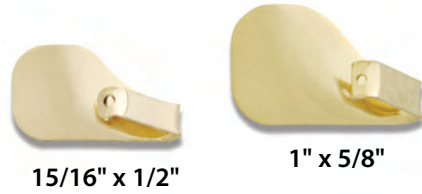

Approximate Size



Side View

- Extremely effective and free spinning blade
- Often used ahead of a weighted treble and bucktail
- Used in inline spinning lure application
- Used as a "Plopper" blade for top water lures

Roto Blades

Size	15/16" x 1/2"	1" x 5/8"
Length (in.)	.884	1.000
Width (in.)	.500	.638
Hole Diameter (in.)	.044	.043
Thickness (in.)	.025	.025
Weight Per Thousand (lbs.)	3.20	4.35
Plain Brass	96904	96906
Call for Pricing		
Polished Brass	96914	96916
See Website for Pricing		
Nickel	96924	96926
See Website for Pricing		

Packaging: Bulk, Polybagged

Quantity Discounts (per size & finish) 5M-9M less 5%, 10M-24M less 10%, 25M-49M less 15%, 50M-99M less 20% 100M-Over less 25%



WARNING: This product can expose you to chemicals including nickel and lead, which are known to the State of California to cause cancer and birth defects or other reproductive harm. For more information, visit www.P65Warnings.ca.gov



Inline



Approximate Size

Inline Blades - Smooth

Size	2	3	4	5
Length (in.)	1.062	1.250	1.500	1.750
Width (in.)	.497	.584	.701	.818
Hole Diameter (in.)	.058	.055	.065	.064
Thickness (in.)	.025	.025	.025	.025
Weight Per Thousand (lbs.)	3.40	4.44	6.42	8.84
Plain Brass	98512	98513	98514	98515
Call for Pricing				
Polished Brass	98522	98523	98524	98525
See Website for Pricing				
Nickeled	98532	98533	98534	98535
See Website for Pricing				
Gold Plate	98542	98543	98544	98545
Call for Pricing				

Packaging: Bulk, Polybagged

Quantity Discounts (per size & finish) 5M-9M less 5%, 10M-24M less 10%, 25M-49M less 15%, 50M-99M less 20% 100M-Over less 25% **Discounts not available on gold.**

Inline Blades - Painted One Side

Size	2	3	4	5
Product Number	77201	77301	77401	77501
Call for Pricing				

Inline Blades - Painted Two Sides

Size	2	3	4	5
Product Number	77202	77302	77402	77502
Call for Pricing				

Note: All painted blades are brass material. Prices stated apply to orders of 1,000 pieces (per size and finish)

Painted blades are not stock items. Please allow 2-3 weeks for delivery.



WARNING: This product can expose you to chemicals including nickel and lead, which are known to the State of California to cause cancer and birth defects or other reproductive harm. For more information, visit www.P65Warnings.ca.gov



Inline

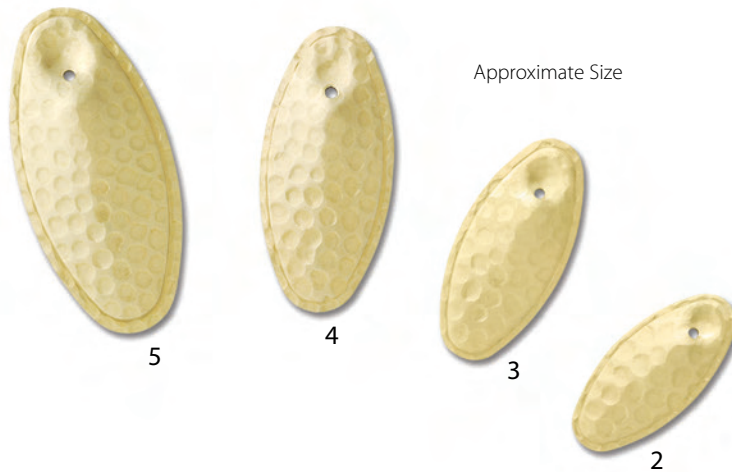

- Extremely popular spinner blade used in inline spinning lures
- Unique self-cleaving design
- Designed for maximum blade movement

Inline Blades - Hammered

Size	2	3	4	5
Length (in.)	1.062	1.250	1.500	1.750
Width (in.)	.497	.584	.701	.818
Hole Diameter (in.)	.054	.058	.066	.061
Thickness (in.)	.025	.025	.025	.025
Weight Per Thousand (lbs.)	3.40	4.02	5.95	8.84
Plain Brass	98612	98613	98614	98615
Call for Pricing				
Polished Brass	98622	98623	98624	98625
See Website for Pricing				
Nickeled	98632	98633	98634	98635
See Website for Pricing				
Gold Plate	98642	98643	98644	98645
Call for Pricing				

Packaging: Bulk, Polybagged

Quantity Discounts (per size & finish)

5M-9M less 5%, 10M-24M less 10%, 25M-49M less 15%,
50M-99M less 20% 100M-Over less 25% **Discounts not available on gold.**



WARNING: This product can expose you to chemicals including nickel and lead, which are known to the State of California to cause cancer and birth defects or other reproductive harm. For more information, visit www.P65Warnings.ca.gov



June Bug

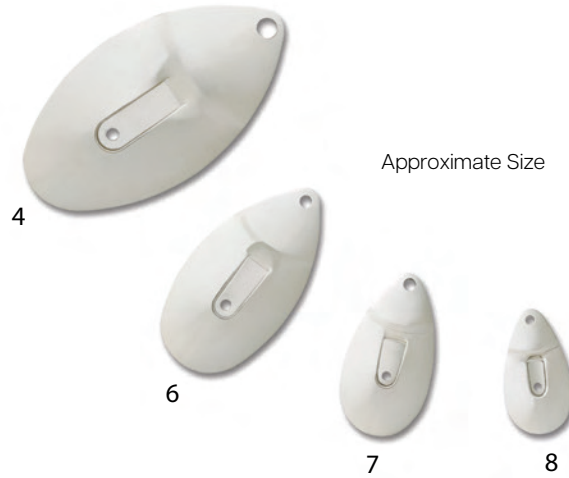

- Self clevising design
- Great option for inline spinners & crawler harnesses
- Clevis arm keeps the blade away from the wire shaft
- Engages quickly and spins freely at slow speeds

June Bug Blades

Size	8	7	6	4
Length (in.)	.658	.877	1.140	1.581
Width (in.)	.350	.468	.601	.842
Hole Diameter 1 Top (in.)	.045	.060	.061	.103
Hole Diameter 2 (in.)	.041	.043	.054	.063
Thickness (in.)	.014	.018	.018	.018
Weight Per Thousand (lbs.)	0.78	1.89	3.13	5.40
Plain Brass	95718	95717	95716	95714
Call for Pricing				
Polished Brass	95728	95727	95726	95724
See Website for Pricing				
Nickel	95738	95737	95736	95734
See Website for Pricing				
Gold Plate	95748	95747	95746	95744
Call for Pricing				

Packaging: Bulk, Polybagged

Quantity Discounts (per size & finish)

5M-9M less 5%, 10M-24M less 10%, 25M-49M less 15%,
50M-99M less 20% 100M-Over less 25% **Discounts not available on gold.**



WARNING: This product can expose you to chemicals including nickel and lead, which are known to the State of California to cause cancer and birth defects or other reproductive harm. For more information, visit www.P65Warnings.ca.gov



Ripple

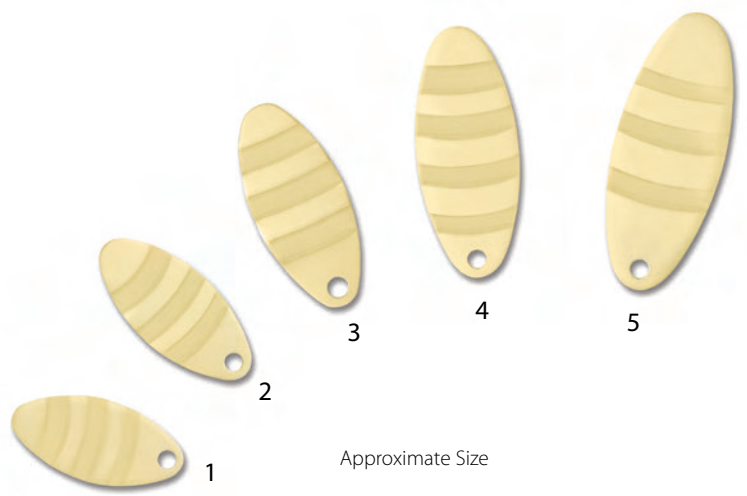

- Versatile spinner blade
- Great for spinnerbaits and inline spinners
- Generates a unique flash and action
- Spins easily and freely

Ripple Blades

Size	1	2	3	4	5
Length (in.)	.928	1.012	1.166	1.328	1.495
Width (in.)	.428	.421	.504	.538	.585
Hole Diameter (in.)	.098	.093	.110	.094	.096
Thickness (in.)	.018	.018	.018	.018	.018
Weight Per Thousand (lbs.)	1.65	1.87	2.54	3.09	3.64
Plain Brass	93711	93712	93713	93714	93715
Call for Pricing					
Polished Brass	93721	93722	93723	93724	93725
See Website for Pricing					
Nickled	93731	93732	93733	93734	93735
See Website for Pricing					
Gold Plate	93741	93742	93743	93744	93745
Call for Pricing					

Packaging: Bulk, Polybagged

Quantity Discounts (per size & finish)

5M-9M less 5%, 10M-24M less 10%, 25M-49M less 15%, 50M-99M less, 20% 100M-Over less 25% **Discounts not available on gold.**



WARNING: This product can expose you to chemicals including nickel and lead, which are known to the State of California to cause cancer and birth defects or other reproductive harm. For more information, visit www.P65Warnings.ca.gov



Colorado

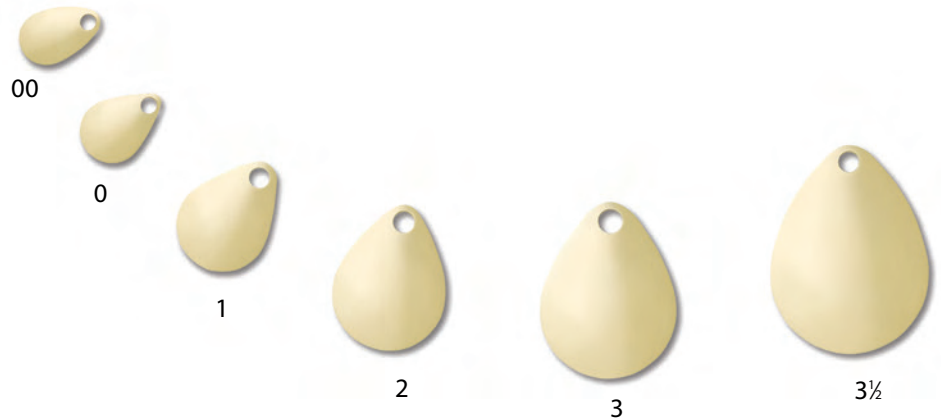

- Maximum vibration & lift
- Perfect for spinnerbaits
- Excellent for inline spinners
- Great for crawler harnesses
- Easy to engage & keep spinning
- Classic spinner blade design

Colorado Blades - Smooth

Size	00	0	1	2	3	3 1/2
Length (in.)	.440	.476	.643	.772	.926	1.094
Width (in.)	.283	.334	.479	.592	.710	.826
Hole Diameter (in.)	.083	.083	.110	.108	.125	.117
Thickness (in.)	.012	.012	.014	.014	.018	.018
Weight Per Thousand (lbs.)	.33	.44	.94	1.43	2.71	3.89
Plain Brass	93809	93800	93801	93802	93803	93807
Call for Pricing						
Polished Brass	93819	93810	93811	93812	93813	93817
See Website for Pricing						
Polished Brass Lacquered	94009	94000	94001	94002	94003	94007
See Website for Pricing						
Nickeled	93829	93820	93821	93822	93823	93827
See Website for Pricing						
Gold Plate	93839	93830	93831	93832	93833	93837
Call for Pricing						

Packaging: Bulk, Polybagged

Quantity Discounts (per size & finish) 5M-9M less 5%, 10M-24M less 10%, 25M-49M less 15%, 50M-99M less 20%, 100M-Over less 25% **Discounts not available on gold.**



WARNING: This product can expose you to chemicals including nickel and lead, which are known to the State of California to cause cancer and birth defects or other reproductive harm. For more information, visit www.P65Warnings.ca.gov



Colorado - Aspen



Colorado Aspen Blades - Smooth

Size	4	4 1/2	5	6	7	8
Length (in.)	1.215	1.308	1.380	1.532	1.795	1.989
Width (in.)	.900	.965	1.082	1.190	1.325	1.392
Hole Diameter (in.)	.125	.125	.125	.152	.152	.152
Thickness (in.)	.018	.018	.018	.018	.018	.018
Weight Per Thousand (lbs.)	4.41	5.16	6.05	7.21	9.75	11.29
Plain Brass	9A804	9A808	9A805	9A806	9A970	9A108
Call for Pricing						
Polished Brass	9A814	9A818	9A815	9A816	9A971	9A118
See Website for Pricing						
Polished Brass Lacquered	9A004	9A008	9A005	9A006	9A972	9A908
See Website for Pricing						
Nickeled	9A824	9A828	9A825	9A826	9A975	9A128
See Website for Pricing						
Gold Plate	9A834	9A838	9A835	9A836	9A976	9A138
Call for Pricing						

Packaging: Bulk, Polybagged

Quantity Discounts (per size): 5M-9M less 5%, 10M-24M less 10%, 25M-49M less 15%, 50M-99M less 20% 100M-Over less 25%
Discounts not available on gold.

Colorado Aspen Blades - Painted Two Sides

Size	2	3	3 1/2	4	4 1/2	5	6	7	8
Product Number	7V202	7V302	7VJ02	7V402	7VK02	7V502	7V602	7V702	7V802
Call for Pricing									

Note: All painted blades are brass material. Prices stated refer to smooth blades and apply to orders of 1,000 pieces (per size and finish).

Painted blades are not stock items. Please allow 2-3 weeks for delivery.



WARNING: This product can expose you to chemicals including nickel and lead, which are known to the State of California to cause cancer and birth defects or other reproductive harm. For more information, visit www.P65Warnings.ca.gov



Colorado



- Maximum vibration & lift
- Perfect for spinnerbaits
- Excellent for inline spinners
- Great for crawler harnesses
- Easy to engage & keep spinning
- Classic spinner blade design

Colorado Blades - Hammered

Size	00	0	1	2	3	3 1/2
Length (in.)	.440	.476	.643	.772	.926	1.094
Width (in.)	.283	.334	.479	.592	.710	.826
Hole Diameter (in.)	.081	.082	.104	.103	.124	.118
Thickness (in.)	.012	.012	.014	.014	.018	.018
Weight Per Thousand (lbs.)	0.33	0.39	0.94	1.43	2.65	3.80
Plain Brass	93859	93850	93851	93852	93853	93857
Call for Pricing						
Polished Brass	93869	93860	93861	93862	93863	93867
See Website for Pricing						
Polished Brass Lacquered	94019	94010	94011	94012	94013	94017
See Website for Pricing						
Nickeled	93879	93870	93871	93872	93873	93877
See Website for Pricing						
Gold Plate	93889	93880	93881	93882	93883	93887
Call for Pricing						

Packaging: Bulk, Polybagged

Quantity Discounts (per size & finish) 5M-9M less 5%, 10M-24M less 10%, 25M-49M less 15%, 50M-99M less 20% 100M-Over less 25% **Discounts not available on gold.**



WARNING: This product can expose you to chemicals including nickel and lead, which are known to the State of California to cause cancer and birth defects or other reproductive harm. For more information, visit www.P65Warnings.ca.gov



Colorado

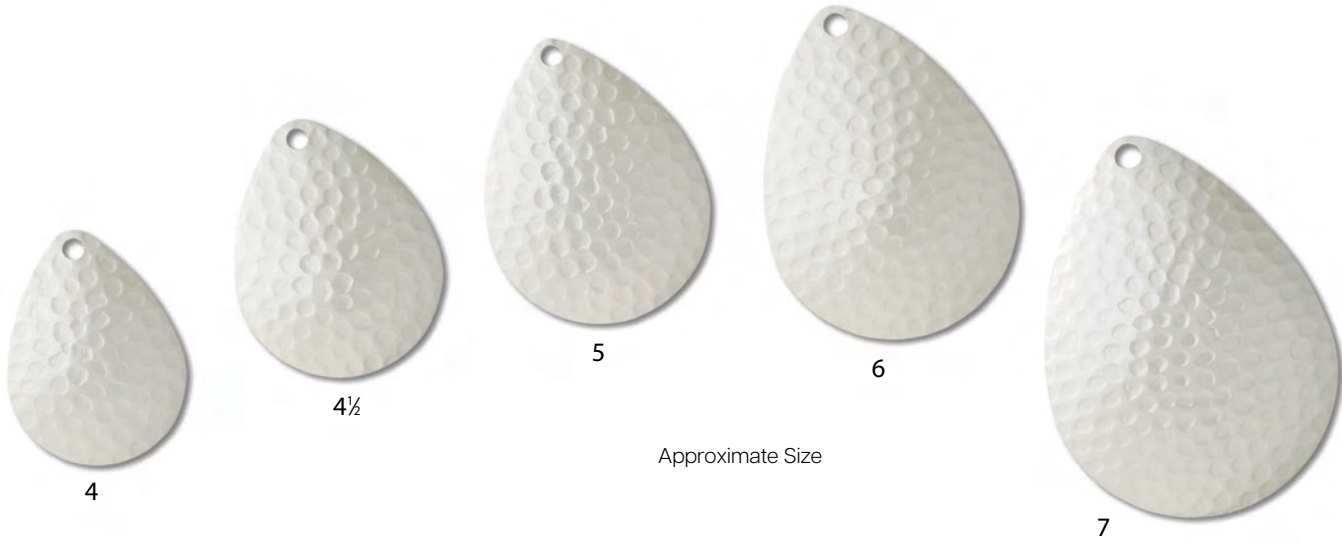

Colorado Blades - Hammered

Size	4	4 1/2	5	6	7
Length (in.)	1.244	1.380	1.536	1.796	2.038
Width (in.)	.942	1.080	1.160	1.321	1.513
Hole Diameter (in.)	.121	.120	.120	.150	.150
Thickness (in.)	.018	.018	.018	.018	.018
Weight Per Thousand (lbs.)	4.23	6.28	7.27	8.88	11.96
Plain Brass	93854	93858	93855	93856	94977
Call for Pricing					
Polished Brass	93864	93868	93865	93866	94978
See Website for Pricing					
Polished Brass Lacquered	94014	94018	94015	94016	94979
See Website for Pricing					
Nickel	93874	93878	93875	93876	94982
See Website for Pricing					
Gold Plate	93884	93888	93885	93886	94983
Call for Pricing					

Packaging: Bulk, Polybagged

Quantity Discounts (per size & finish) 5M-9M less 5%, 10M-24M less 10%, 25M-49M less 15%, 50M-99M less 20%, 100M-Over less 25% **Discounts not available on gold.**



WARNING: This product can expose you to chemicals including nickel and lead, which are known to the State of California to cause cancer and birth defects or other reproductive harm. For more information, visit www.P65Warnings.ca.gov



Colorado

Painted Items

See our Custom Colors section starting on **page 115** for information on painted items



Colorado Blades - Painted One Side

Size	2	3	3 ½	4	4 ½	5	6	7
Product Number	70201	70301	70J01	70401	70K01	70501	70601	70701
Call for Pricing								

Colorado Blades - Painted Two Sides

Size	2	3	3 ½	4	4 ½	5	6	7
Product Number	70202	70302	70J02	70402	70K02	70502	70602	70702
Call for Pricing								

Note: All painted blades are brass material.

Prices stated refer to smooth blades and apply to orders of 1,000 pieces (per size and finish)

Painted blades are not stock items. Please allow 2-3 weeks for delivery.



WARNING: This product can expose you to chemicals including nickel and lead, which are known to the State of California to cause cancer and birth defects or other reproductive harm. For more information, visit www.P65Warnings.ca.gov



Colorado - Badger



Approximate Size

- Maximum vibration & lift
- Perfect for spinnerbaits
- Great for crawler harnesses & inline spinners
- Easy to engage & keep spinning
- Classic spinner blade design made with thinner material

Colorado Badger

Size	00	0	1	2	3
Length (in.)	.451	.472	.643	.746	.923
Width (in.)	.280	.344	.479	.579	.708
Hole Diameter (in.)	.080	.084	.104	.094	.109
Thickness (in.)	.010	.010	.010	.010	.010
Weight Per Thousand (lbs.)	.28	.40	.70	.93	1.50
Plain Brass	95009	95000	95001	95002	95003
Call for Pricing					
Polished Brass	95109	95100	95101	95102	95103
See Website for Pricing					
Nickeled	95209	95200	95201	95202	95203
See Website for Pricing					

Not available in hammered finishes.

Packaging: Bulk, Polybagged

Quantity Discounts (per size & finish) 5M-9M less 5%, 10M-24M less 10%, 25M-49M less 15%, 50M-99M less 20%, 100M-Over less 25%



WARNING: This product can expose you to chemicals including nickel and lead, which are known to the State of California to cause cancer and birth defects or other reproductive harm. For more information, visit www.P65Warnings.ca.gov



Colorado - Steel



Also available in hammered and hex.

Colorado Steel Blades

Size	0	1	2	3	3 1/2
Length (in.)	.476	.643	.772	.926	1.094
Width (in.)	.334	.479	.592	.710	.826
Hole Diameter (in.)	.084	.104	.107	.125	.111
Thickness (in.)	.015	.015	.015	.018	.018
Smooth Nickerled	86620	86621	86622	86623	86627
Weight Per Thousand (lbs.)	.56	1.15	1.68	2.54	3.64
See Website for Pricing					
Hammered Nickerled	86670	86671	86672	86673	86677
Weight Per Thousand (lbs.)	.56	1.15	1.68	2.15	3.58
See Website for Pricing					
Hex Nickerled	-	-	-	86573	86577
Weight Per Thousand (lbs.)	-	-	-	2.48	3.58
See Website for Pricing	-	-	-		

Packaging: Bulk, Polybagged

Quantity Discounts (per size & finish) 5M-9M less 5%, 10M-24M less 10%, 25M-49M less 15%, 50M-99M less 20% 100M-Over less 25%

Colorado Steel Blades - Painted One Side

Size	2	3	3 1/2	4
Product Number	7Q201	7Q301	7QJ01	7Q401
Call for Pricing				

Size	4 1/2	5	6	7
Product Number	7QK01	7Q501	7Q601	7Q701
Call for Pricing				

Prices stated refer to smooth blades and apply to orders of 1,000 pieces (per size and finish).

Painted blades are not stock items. Please allow 2-3 weeks for delivery.



WARNING: This product can expose you to chemicals including nickel and lead, which are known to the State of California to cause cancer and birth defects or other reproductive harm. For more information, visit www.P65Warnings.ca.gov



Colorado - Steel



Colorado Steel Blades

Size	4	4 1/2	5	6	7
Length (in.)	1.244	1.380	1.536	1.796	2.052
Width (in.)	.932	1.080	1.160	1.321	1.508
Hole Diameter (in.)	.120	.125	.125	.150	.150
Thickness (in.)	.018	.018	.018	.018	.018
Smooth Nickeled	86624	86634	86625	86626	86637
Weight Per Thousand (lbs.)	4.69	6.28	6.72	8.96	11.86
See Website for Pricing					
Hammered Nickeled	86674	86684	86675	86676	86687
Weight Per Thousand (lbs.)	4.46	5.80	6.72	8.96	11.86
See Website for Pricing					
Hex Nickeled	86574	86578	86575	-	-
Weight Per Thousand (lbs.)	4.46	5.80	6.72	-	-
See Website for Pricing				-	-

Packaging: Bulk, Polybagged

Quantity Discounts (per size): 5M-9M less 5%, 10M-24M less 10%, 25M-49M less 15%, 50M-99M less 20%, 100M-Over less 25%

Colorado Steel Blades - Painted Two Sides

Size	2	3	3 1/2	4
Product Number	7Q202	7Q302	7QJ02	7Q402
Call for Pricing				

Size	4 1/2	5	6	7
Product Number	7QK02	7Q502	7Q602	7Q702
Call for Pricing				

Prices stated refer to smooth blades and apply to orders of 1,000 pieces (per size and finish)

Painted blades are not stock items. Please allow 2-3 weeks for delivery.



WARNING: This product can expose you to chemicals including nickel and lead, which are known to the State of California to cause cancer and birth defects or other reproductive harm. For more information, visit www.P65Warnings.ca.gov



Colorado - Aspen

- Maximum vibration & lift
- Perfect for spinnerbaits
- Excellent for inline spinners
- Great for crawler harnesses
- Easy to engage & keep spinning
- Classic design with increased cupping



Colorado Aspen Blades - Smooth

Size	00	0	1	1 1/2	2	3	3 1/2
Length (in.)	.445	.590	.692	.758	.891	1.012	1.105
Width (in.)	.368	.432	.524	.590	.685	.724	.820
Hole Diameter (in.)	.090	.096	.096	.108	.108	.116	.120
Thickness (in.)	.018	.018	.018	.018	.018	.018	.018
Weight Per Thousand (lbs.)	.63	1.00	1.46	1.85	2.42	2.94	3.63
Plain Brass	9A809	9A800	9A801	9A101	9A802	9A803	9A807
Call for Pricing							
Polished Brass	9A819	9A810	9A811	9A111	9A812	9A813	9A817
See Website for Pricing							
Polished Brass Lacquered	9A009	9A000	9A001	9A901	9A002	9A003	9A007
See Website for Pricing							
Nickeled	9A829	9A820	9A821	9A121	9A822	9A823	9A827
See Website for Pricing							
Gold Plate	9A839	9A830	9A831	9A131	9A832	9A833	9A837
Call for Pricing							

Packaging: Bulk, Polybagged

Quantity Discounts (per size): 5M-9M less 5%, 10M-24M less 10%, 25M-49M less 15%, 50M-99M less 20% 100M-Over less 25% **Discounts not available on gold.**

Colorado Aspen Blades - Painted One Side

Size	2	3	3 1/2	4	4 1/2	5	6	7	8
Product Number	7V201	7V301	7VJ01	7V401	7VK01	7V501	7V601	7V701	7V801
Call for Pricing									

Note: All painted blades are brass material. Prices stated refer to smooth blades and apply to orders of 1,000 pieces (per size and finish).

Painted blades are not stock items. Please allow 2-3 weeks for delivery.



WARNING: This product can expose you to chemicals including nickel and lead, which are known to the State of California to cause cancer and birth defects or other reproductive harm. For more information, visit www.P65Warnings.ca.gov



Colorado - Aspen



Colorado Aspen Blades - Smooth

Size	4	4 1/2	5	6	7	8
Length (in.)	1.215	1.308	1.380	1.532	1.795	1.989
Width (in.)	.900	.965	1.082	1.190	1.325	1.392
Hole Diameter (in.)	.125	.125	.125	.152	.152	.152
Thickness (in.)	.018	.018	.018	.018	.018	.018
Weight Per Thousand (lbs.)	4.41	5.16	6.05	7.21	9.75	11.29
Plain Brass	9A804	9A808	9A805	9A806	9A970	9A108
Call for Pricing						
Polished Brass	9A814	9A818	9A815	9A816	9A971	9A118
See Website for Pricing						
Polished Brass Lacquered	9A004	9A008	9A005	9A006	9A972	9A908
See Website for Pricing						
Nickeled	9A824	9A828	9A825	9A826	9A975	9A128
See Website for Pricing						
Gold Plate	9A834	9A838	9A835	9A836	9A976	9A138
Call for Pricing						

Packaging: Bulk, Polybagged

Quantity Discounts (per size): 5M-9M less 5%, 10M-24M less 10%, 25M-49M less 15%, 50M-99M less 20% 100M-Over less 25%
Discounts not available on gold.

Colorado Aspen Blades - Painted Two Sides

Size	2	3	3 1/2	4	4 1/2	5	6	7	8
Product Number	7V202	7V302	7VJ02	7V402	7VK02	7V502	7V602	7V702	7V802
Call for Pricing									

Note: All painted blades are brass material. Prices stated refer to smooth blades and apply to orders of 1,000 pieces (per size and finish). Painted blades are not stock items. Please allow 2-3 weeks for delivery.



WARNING: This product can expose you to chemicals including nickel and lead, which are known to the State of California to cause cancer and birth defects or other reproductive harm. For more information, visit www.P65Warnings.ca.gov



Colorado - Aspen



- Maximum vibration & lift
- Perfect for spinnerbaits
- Great for crawler harnesses & inline spinners
- Easy to engage & keep spinning
- Classic design with increased cupping

Colorado Aspen Blades - Hammered

Size	00	0	1	1 1/2	2	3	3 1/2
Length (in.)	.445	.590	.692	.758	.891	1.012	1.105
Width (in.)	.368	.432	.524	.590	.685	.724	.820
Hole Diameter (in.)	.090	.096	.096	.108	.108	.116	.120
Thickness (in.)	.018	.018	.018	.018	.018	.018	.018
Weight Per Thousand (lbs.)	.63	1.00	1.46	1.85	2.42	2.94	3.63
Plain Brass	9A859	9A850	9A851	9A151	9A852	9A853	9A857
Call for Pricing							
Polished Brass	9A869	9A860	9A861	9A161	9A862	9A863	9A867
See Website for Pricing							
Polished Brass Lacquered	9A019	9A010	9A011	9A911	9A012	9A013	9A017
See Website for Pricing							
Nickeled	9A879	9A870	9A871	9A171	9A872	9A873	9A877
See Website for Pricing							
Gold Plate	9A889	9A880	9A881	9A181	9A882	9A883	9A887
Call for Pricing							

Packaging: Bulk, Polybagged

Quantity Discounts (per size): 5M-9M less 5%, 10M-24M less 10%, 25M-49M less 15%, 50M-99M less 20% 100M-Over less 25%

Discounts not available on gold.



WARNING: This product can expose you to chemicals including nickel and lead, which are known to the State of California to cause cancer and birth defects or other reproductive harm. For more information, visit www.P65Warnings.ca.gov



Colorado - Aspen

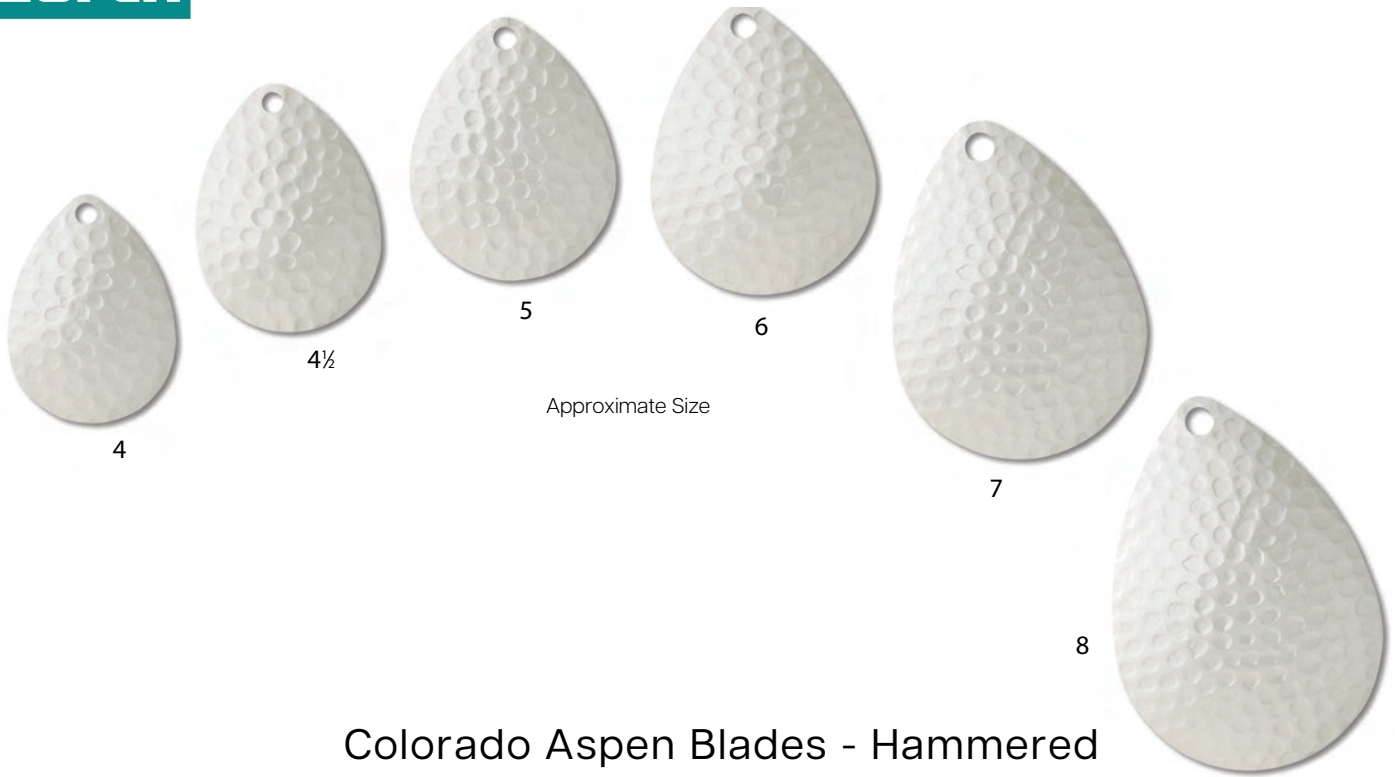

Colorado Aspen Blades - Hammered

Size	4	4 1/2	5	6	7	8
Length (in.)	1.215	1.308	1.380	1.532	1.795	1.989
Width (in.)	.900	.965	1.082	1.190	1.325	1.392
Hole Diameter (in.)	.125	.125	.125	.152	.152	.152
Thickness (in.)	.018	.018	.018	.018	.018	.018
Weight Per Thousand (lbs.)	4.41	5.16	6.05	7.21	9.60	11.10
Plain Brass	9A854	9A858	9A855	9A856	9A977	9A158
Call for Pricing						
Polished Brass	9A864	9A868	9A865	9A866	9A978	9A168
See Website for Pricing						
Polished Brass Lacquered	9A014	9A018	9A015	9A016	9A979	9A918
See Website for Pricing						
Nickel	9A874	9A878	9A875	9A876	9A982	9A178
See Website for Pricing						
Gold Plate	9A884	9A888	9A885	9A886	9A983	9A188
Call for Pricing						

Packaging: Bulk, Polybagged

Quantity Discounts (per size): 5M-9M less 5%, 10M-24M less 10%, 25M-49M less 15%, 50M-99M less 20% 100M-Over less 25%

Discounts not available on gold.



WARNING: This product can expose you to chemicals including nickel and lead, which are known to the State of California to cause cancer and birth defects or other reproductive harm. For more information, visit www.P65Warnings.ca.gov



Colorado - Aspen



Colorado Aspen Blades - Hex

Size	2	3	3 1/2	4	4 1/2	5	6	7	8
Length (in.)	.891	1.012	1.105	1.215	1.308	1.380	1.532	1.795	1.989
Width (in.)	.685	.724	.820	.900	.965	1.082	1.190	1.325	1.392
Hole Diameter (in.)	.108	.116	.120	.125	.125	.125	.152	.152	.152
Thickness (in.)	.018	.018	.018	.018	.018	.018	.018	.018	.018
Weight Per Thousand (lbs.)	2.42	2.94	3.63	4.41	5.16	6.05	7.21	9.75	11.10
Plain Brass	9A252	9A253	9A257	9A254	9A258	9A255	9A256	9A227	9A228
Call for Pricing									
Polished Brass	9A262	9A263	9A267	9A264	9A268	9A265	9A266	9A237	9A238
See Website for Pricing									
Polished Brass Lacquered	9A212	9A213	9A217	9A214	9A218	9A215	9A216	9A980	9A981
See Website for Pricing									
Nickel	9A272	9A273	9A277	9A274	9A278	9A275	9A276	9A247	9A248
See Website for Pricing									
Gold Plate	9A282	9A283	9A287	9A284	9A288	9A285	9A286	9A297	9A298
Call for Pricing									

Packaging: Bulk, Polybagged

Quantity Discounts (per size): 5M-9M less 5%, 10M-24M less 10%, 25M-49M less 15%, 50M-99M less 20% 100M-Over less 25%

Discounts not available on gold.



WARNING: This product can expose you to chemicals including nickel and lead, which are known to the State of California to cause cancer and birth defects or other reproductive harm. For more information, visit www.P65Warnings.ca.gov



Colorado - Aspen - Steel



Approximate Size

- Maximum vibration & lift
- Perfect for spinnerbaits
- Great for crawler harnesses & inline spinners
- Easy to engage & keep spinning
- Classic design with increased cupping

Colorado Aspen Steel Blades

Size	2	3	4	5	6	7	8
Length (in.)	.891	1.012	1.215	1.380	1.532	1.795	1.989
Width (in.)	.685	.724	.900	1.082	1.190	1.344	1.397
Hole Diameter (in.)	.108	.116	.125	.125	.152	.152	.152
Thickness (in.)	.018	.018	.018	.018	.018	.018	.018
Weight Per Thousand (lbs.)	2.24	2.72	4.08	5.60	6.66	8.86	10.27
Nickeled	8A812	8A813	8A814	8A815	8A816	8A817	8A818
See Website for Pricing							

Packaging: Bulk, Polybagged

Quantity Discounts (per size): 5M-9M less 5%, 10M-24M less 10%, 25M-49M less 15%,
50M-99M less 20% 100M-Over less 25%



WARNING: This product can expose you to chemicals including nickel and lead, which are known to the State of California to cause cancer and birth defects or other reproductive harm. For more information, visit www.P65Warnings.ca.gov



Colorado - Aspen Deep Cup

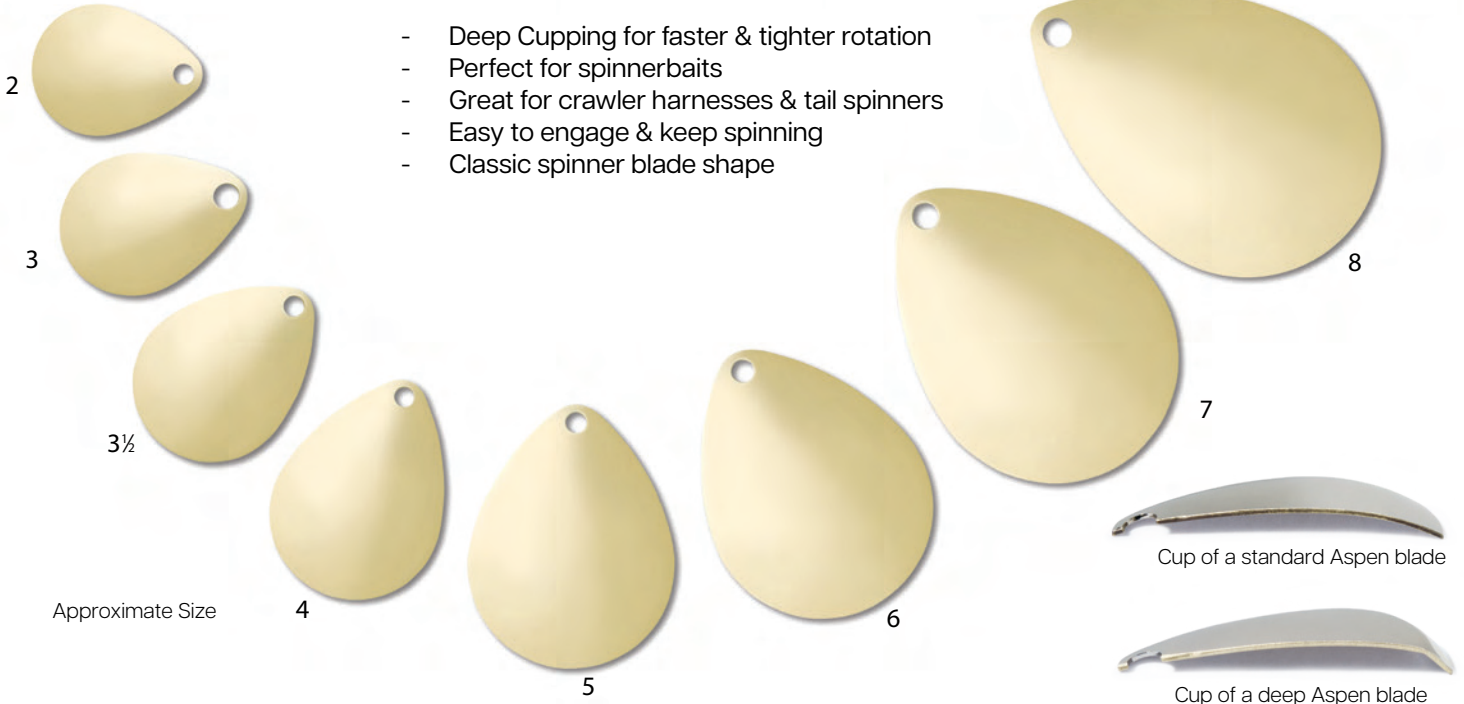

- Deep Cupping for faster & tighter rotation
- Perfect for spinnerbaits
- Great for crawler harnesses & tail spinners
- Easy to engage & keep spinning
- Classic spinner blade shape

Colorado Aspen Deep Cup Blades - Smooth

Size	2	3	3 ½	4	5	6	7	8
Length (in.)	.891	1.012	1.105	1.215	1.380	1.532	1.795	1.989
Width (in.)	.685	.724	.820	.90	1.082	1.190	1.325	1.392
Hole Diameter (in.)	.108	.116	.120	.125	.125	.152	.152	.152
Thickness (in.)	.018	.018	.018	.018	.018	.018	.018	.018
Weight Per Thousand (lbs.)	2.42	2.94	3.63	4.41	6.05	7.21	9.60	11.10
Plain Brass	94601	94602	94603	94604	94605	94606	94607	94608
Call for Pricing								
Polished Brass	94611	94612	94613	94614	94615	94616	94617	94618
See Website for Pricing								
Polished Brass Lacquered	97171	97172	97173	97174	97175	97176	97177	97178
See Website for Pricing								
Nickeled	94621	94622	94623	94624	94625	94626	94627	94628
See Website for Pricing								
Gold Plate	94631	94632	94633	94634	94635	94636	94637	94638
Call for Pricing								

Packaging: Bulk, Polybagged

Quantity Discounts (per size): 5M-9M less 5%, 10M-24M less 10%, 25M-49M less 15%, 50M-99M less 20% 100M-Over less 25% **Discounts not available on gold.**



WARNING: This product can expose you to chemicals including nickel and lead, which are known to the State of California to cause cancer and birth defects or other reproductive harm. For more information, visit www.P65Warnings.ca.gov



Colorado - Aspen Deep Cup



Colorado Aspen Deep Cup Blades - Hammered

Size	2	3	3 ½	4	5	6	7	8
Length (in.)	.891	1.012	1.105	1.215	1.380	1.532	1.795	1.989
Width (in.)	.685	.724	.820	.900	1.082	1.190	1.325	1.392
Hole Diameter (in.)	.108	.116	.120	.125	.125	.152	.152	.152
Thickness (in.)	.018	.018	.018	.018	.018	.018	.018	.018
Weight Per Thousand (lbs.)	2.42	3.19	3.63	4.92	6.05	7.80	9.60	11.10
Plain Brass	94651	94652	94653	94654	94655	94656	94657	94658
Call for Pricing								
Polished Brass	94661	94662	94663	94664	94665	94666	94667	94668
See Website for Pricing								
Polished Brass Lacquered	97191	97192	97193	97194	97195	97196	97197	97198
See Website for Pricing								
Nickeled	94671	94672	94673	94674	94675	94676	94677	94678
See Website for Pricing								
Gold Plate	94681	94682	94683	94684	94685	94686	94687	94688
Call for Pricing								

Packaging: Bulk, Polybagged

Quantity Discounts (per size): 5M-9M less 5%, 10M-24M less 10%, 25M-49M less 15%, 50M-99M less 20% 100M-Over less 25% **Discounts not available on gold.**



WARNING: This product can expose you to chemicals including nickel and lead, which are known to the State of California to cause cancer and birth defects or other reproductive harm. For more information, visit www.P65Warnings.ca.gov



Colorado - Aspen Deep Cup



Cup of a standard Aspen blade



Cup of a deep Aspen blade

Colorado Aspen Deep Cup Blades - Hex Pattern

Size	2	3	3 1/2	4	5	6	7	8
Length (in.)	.891	1.012	1.105	1.215	1.380	1.532	1.795	1.989
Width (in.)	.685	.724	.820	.900	1.082	1.190	1.325	1.392
Hole Diameter (in.)	.108	.116	.120	.125	.125	.152	.152	.152
Thickness (in.)	.018	.018	.018	.018	.018	.018	.018	.018
Weight Per Thousand (lbs.)	2.42	3.19	3.83	4.41	6.49	7.80	9.60	11.10
Plain Brass	94691	94692	94693	94694	94695	94696	94697	94698
Call for Pricing								
Polished Brass	94641	94642	94643	94644	94645	94646	94647	94648
See Website for Pricing								
Polished Brass Lacquered	97181	97182	97183	97184	97185	97186	97187	97188
See Website for Pricing								
Nickeled	97161	97162	97163	97164	97165	97166	97167	97168
See Website for Pricing								
Gold Plate	97151	97152	97153	97154	97155	97156	97157	97158
Call for Pricing								

Packaging: Bulk, Polybagged

Quantity Discounts (per size): 5M-9M less 5%, 10M-24M less 10%, 25M-49M less 15%, 50M-99M less 20% 100M-Over less 25% **Discounts not available on gold.**



WARNING: This product can expose you to chemicals including nickel and lead, which are known to the State of California to cause cancer and birth defects or other reproductive harm. For more information, visit www.P65Warnings.ca.gov



Ice Blades

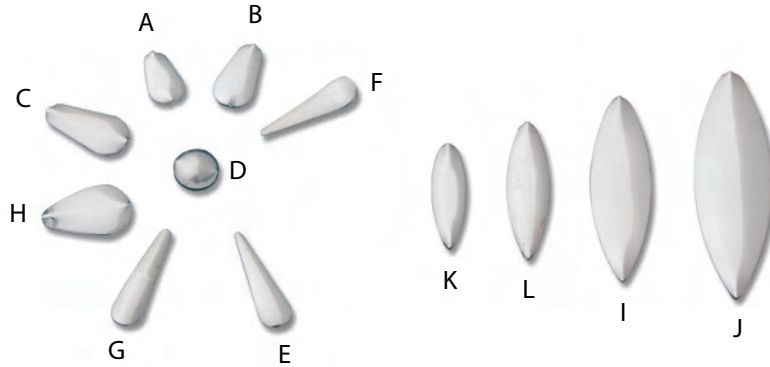

Approximate Size

- Ideal for jigs and ice fishing lures
- Multiple sizes & shape options
- High flash and visibility
- Made from high quality brass

Ice Blades

Size	A	B	C	D	E	F	G	H	I	J	K	L
Length (in.)	.300	.370	.435	.216	.535	.525	.545	.433	1.013	1.236	.566	.743
Width (in.)	.184	.206	.224	.216	.159	.159	.151	.279	.301	.381	.174	.209
Weight Per Thousand (lbs.)	0.12	0.17	0.23	0.17	0.16	0.17	0.28	0.28	0.66	1.04	0.28	0.33
Plain Brass	96011	96012	96013	96110	96210	96310	96410	98910	98920	98930	98940	98950
See Website for Pricing												
Polished Brass	96021	96022	96023	96120	96220	96320	96420	98911	98921	98931	98941	98951
See Website for Pricing												
Nickeled	96031	96032	96033	96130	96230	96330	96430	98912	98922	98932	98942	98952
See Website for Pricing												
Gold Plate	96041	96042	96043	96140	96240	96340	96440	98913	98923	98933	98943	98953
Call for Pricing												

Packaging: Bulk, Polybagged

Quantity Discounts (per size): 5M-9M less 5%, 10M-24M less 10%, 25M-49M less 15%, 50M-99M less 20% 100M-Over less 25% **Discounts not available on gold.**



WARNING: This product can expose you to chemicals including nickel and lead, which are known to the State of California to cause cancer and birth defects or other reproductive harm. For more information, visit www.P65Warnings.ca.gov



Indiana

- Extremely versatile spinner blade
- Perfect for spinnerbaits
- Great for inline spinners & crawler harnesses
- Intermediate running depth
- Great combination of flash and vibration
- Classic spinner blade design



Indiana Blades - Smooth

Size	00	0	1	2	3	4
Length (in.)	.434	.546	.702	.843	.992	1.118
Width (in.)	.279	.320	.406	.476	.584	.616
Hole Diameter (in.)	.077	.077	.083	.086	.094	.095
Thickness (in.)	.012	.012	.014	.014	.018	.018
Weight Per Thousand (lbs.)	0.33	0.45	0.94	1.27	2.45	2.91
Plain Brass	94309	94300	94301	94302	94303	94304
Call for Pricing						
Polished Brass	94319	94310	94311	94312	94313	94314
See Website for Pricing						
Polished Brass Lacquered	94029	94020	94021	94022	94023	94024
See Website for Pricing						
Nickeled	94329	94320	94321	94322	94323	94324
See Website for Pricing						
Gold Plate	94339	94330	94331	94332	94333	94334
Call for Pricing						

Packaging: Bulk, Polybagged

Quantity Discounts (per size): 5M-9M less 5%, 10M-24M less 10%, 25M-49M less 15%, 50M-99M less 20% 100M-Over less 25%

Discounts not available on gold.



WARNING: This product can expose you to chemicals including nickel and lead, which are known to the State of California to cause cancer and birth defects or other reproductive harm. For more information, visit www.P65Warnings.ca.gov



Indiana

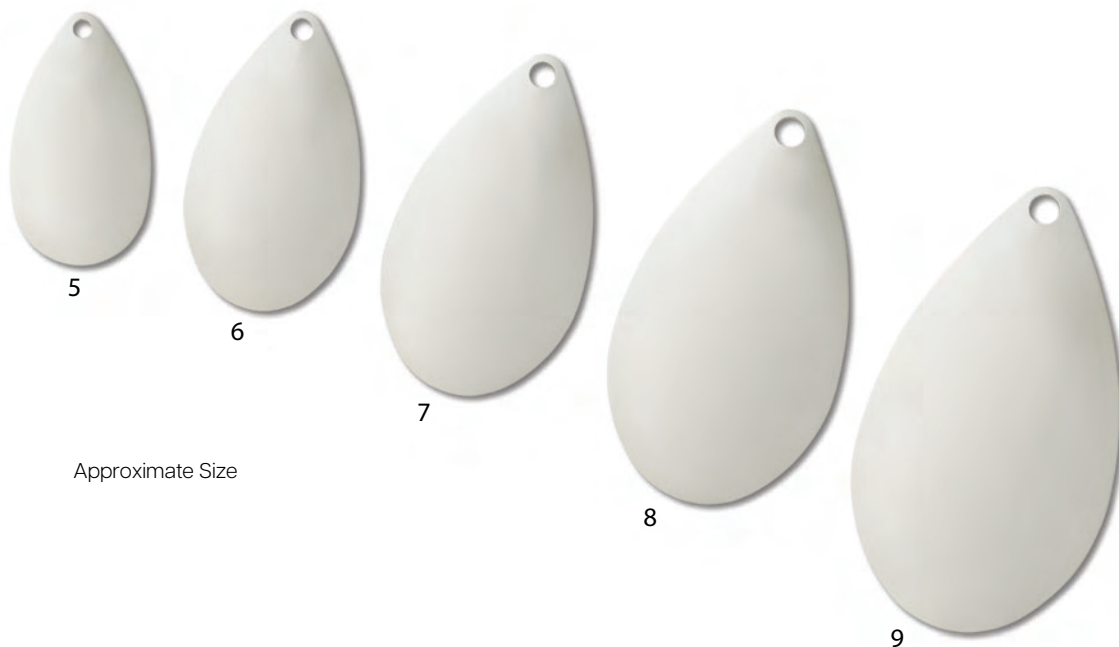

Approximate Size

Indiana Blades - Smooth

Size	5	6	7	8	9
Length (in.)	1.328	1.590	1.850	2.125	2.364
Width (in.)	.738	.906	1.062	1.202	1.358
Hole Diameter (in.)	.093	.112	.131	.153	.152
Thickness (in.)	.018	.018	.018	.020	.020
Weight Per Thousand (lbs.)	4.22	5.95	8.31	12.75	16.14
Plain Brass	94305	94306	94307	94308	94409
Call for Pricing					
Polished Brass	94315	94316	94317	94318	94419
See Website for Pricing					
Polished Brass Lacquered	94025	94026	94027	94028	94429
See Website for Pricing					
Nickeled	94325	94326	94327	94328	94459
See Website for Pricing					
Gold Plate	94335	94336	94337	94338	94489
Call for Pricing					

Packaging: Bulk, Polybagged

Quantity Discounts (per size): 5M-9M less 5%, 10M-24M less 10%, 25M-49M less 15%, 50M-99M less 20% 100M-Over less 25%

Discounts not available on gold.



WARNING: This product can expose you to chemicals including nickel and lead, which are known to the State of California to cause cancer and birth defects or other reproductive harm. For more information, visit www.P65Warnings.ca.gov



Indiana



Indiana Blades - Hammered

Size	00	0	1	2	3	4
Length (in.)	.434	.546	.702	.843	.992	1.118
Width (in.)	.279	.320	.406	.476	.584	.618
Hole Diameter (in.)	.077	.077	.083	.087	.094	.095
Thickness (in.)	.012	.012	.014	.014	.018	.018
Weight Per Thousand (lbs.)	0.33	0.44	0.94	1.27	2.43	2.87
Plain Brass	94359	94350	94351	94352	94353	94354
Call for Pricing						
Polished Brass	94369	94360	94361	94362	94363	94364
See Website for Pricing						
Polished Brass Lacquered	94039	94030	94031	94032	94033	94034
See Website for Pricing						
Nickel	94379	94370	94371	94372	94373	94374
See Website for Pricing						
Gold Plate	94389	94380	94381	94382	94383	94384
Call for Pricing						

Packaging: Bulk, Polybagged

Quantity Discounts (per size): 5M-9M less 5%, 10M-24M less 10%, 25M-49M less 15%, 50M-99M less 20% 100M-Over less 25%

Discounts not available on gold.



WARNING: This product can expose you to chemicals including nickel and lead, which are known to the State of California to cause cancer and birth defects or other reproductive harm. For more information, visit www.P65Warnings.ca.gov



Indiana

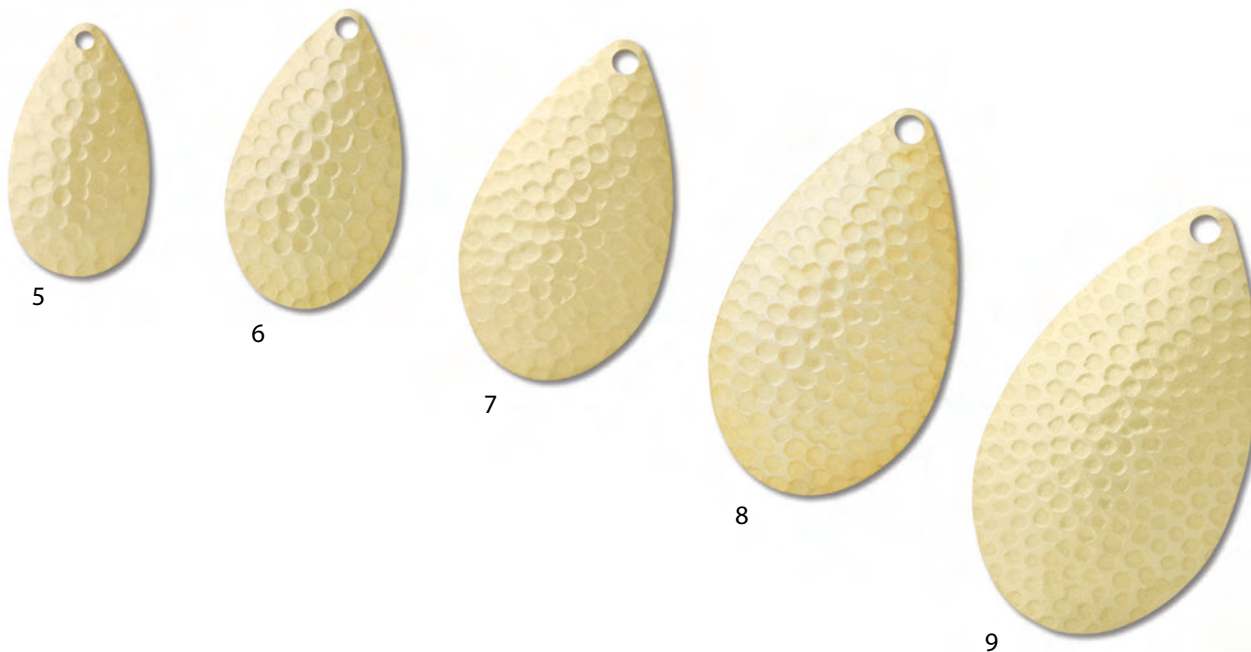

Indiana Blades - Hammered

Size	5	6	7	8	9
Length (in.)	1.328	1.590	1.850	2.125	2.364
Width (in.)	.739	.906	1.062	1.202	1.358
Hole Diameter (in.)	.094	.113	.132	.154	.153
Thickness (in.)	.018	.018	.018	.020	.020
Weight Per Thousand (lbs.)	3.62	5.10	8.38	10.86	13.56
Plain Brass	94355	94356	94357	94358	94400
Call for Pricing					
Polished Brass	94365	94366	94367	94368	94401
See Website for Pricing					
Polished Brass Lacquered	94035	94036	94037	94038	94402
See Website for Pricing					
Nickeled	94375	94376	94377	94378	94405
See Website for Pricing					
Gold Plate	94385	94386	94387	94388	94406
Call for Pricing					

Packaging: Bulk, Polybagged

Quantity Discounts (per size): 5M-9M less 5%, 10M-24M less 10%, 25M-49M less 15%, 50M-99M less 20% 100M-Over less 25%
Discounts not available on gold.



WARNING: This product can expose you to chemicals including nickel and lead, which are known to the State of California to cause cancer and birth defects or other reproductive harm. For more information, visit www.P65Warnings.ca.gov



Indiana

Painted Items

See our Custom Colors section starting on **page 115** for information on painted items



Indiana Blades - Painted One Side

Size	2	3	4	5	6	7	8	9
Product Number	75201	75301	75401	75501	75601	75701	75801	75901
Call for Pricing								

Indiana Blades - Painted Two Sides

Size	2	3	4	5	6	7	8	9
Product Number	75202	75302	75402	75502	75602	75702	75802	75902
Call for Pricing								

Note: All painted blades are brass material.

Prices stated refer to smooth blades and apply to orders of 1,000 pieces (per size and finish)

Painted blades are not stock items. Please allow 2-3 weeks for delivery.



WARNING: This product can expose you to chemicals including nickel and lead, which are known to the State of California to cause cancer and birth defects or other reproductive harm. For more information, visit www.P65Warnings.ca.gov



Indiana - Badger

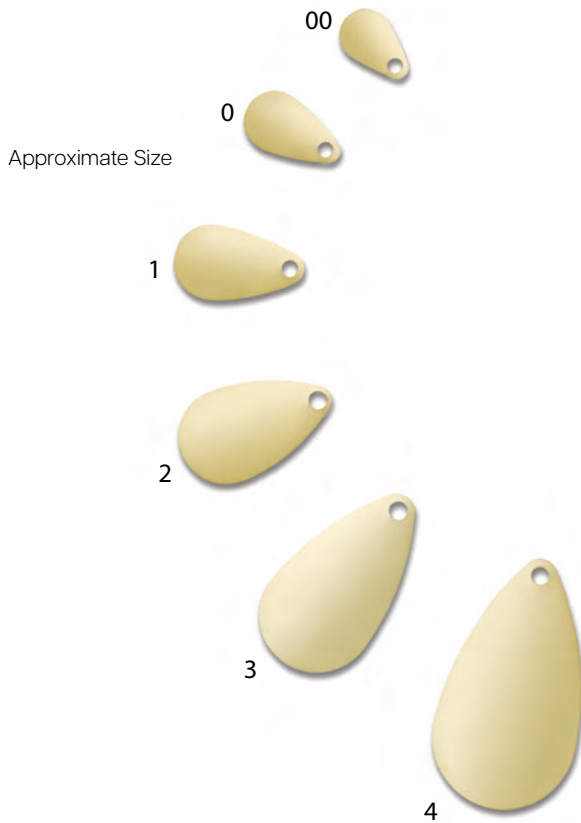

- Extremely versatile spinner blade
- Perfect for spinnerbaits
- Great for inline spinners & crawler harnesses
- Intermediate running depth
- Great combination of flash and vibration
- Classic design made with a thinner material

Indiana Blades Badger Quality

Size	00	0	1	2	3	4
Length (in.)	.434	.546	.684	.836	1.080	1.334
Width (in.)	.279	.320	.394	.500	.606	.748
Hole Diameter (in.)	.076	.077	.084	.093	.092	.091
Thickness (in.)	.010	.010	.010	.010	.010	.010
Weight Per Thousand (lbs.)	0.26	0.39	0.61	.88	1.56	2.32
Plain Brass	95309	95300	95301	95302	95303	95304
Call for Pricing						
Polished Brass	95409	95400	95401	95402	95403	95404
See Website for Pricing						
Nickel	95509	95500	95501	95502	95503	95504
See Website for Pricing						

Not available in hammered finish

Packaging: Bulk, Polybagged

Quantity Discounts (per size): 5M-9M less 5%, 10M-24M less 10%, 25M-49M less 15%, 50M-99M less 20% 100M-Over less 25%



WARNING: This product can expose you to chemicals including nickel and lead, which are known to the State of California to cause cancer and birth defects or other reproductive harm. For more information, visit www.P65Warnings.ca.gov



Indiana - Steel

- Extremely versatile spinner blade
- Perfect for spinnerbaits
- Great for inline spinners & crawler harnesses
- Intermediate running depth
- Great combination of flash and vibration
- Classic spinner blade design

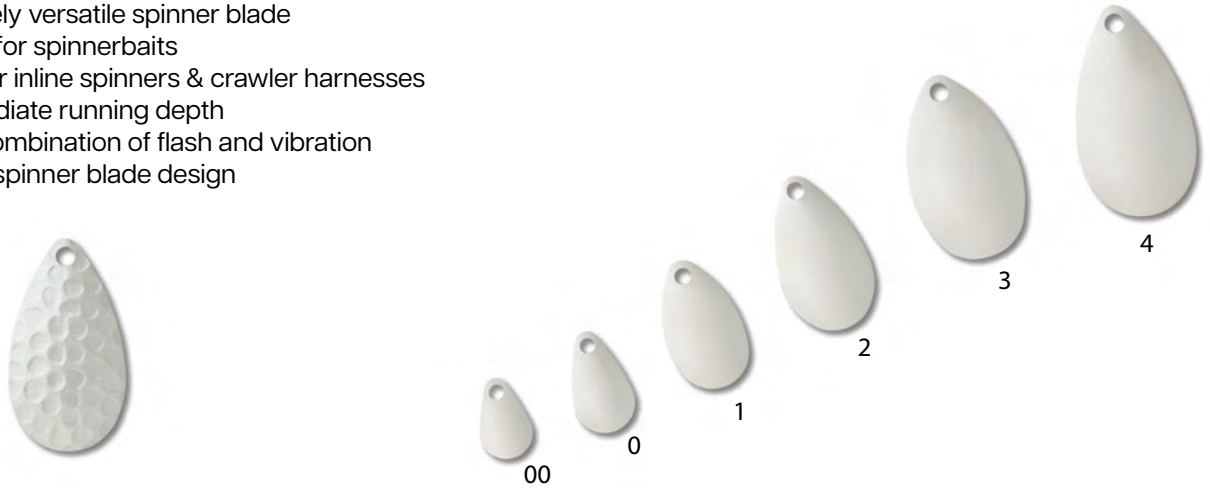

Indiana Steel Blades

Size	00	0	1	2	3	4
Length (in.)	.434	.546	.702	.843	.992	1.118
Width (in.)	.278	.320	.406	.476	.584	.615
Hole Diameter (in.)	.077	.077	.082	.083	.094	.094
Thickness (in.)	.015	.015	.015	.015	.018	.018
Smooth Nickered	86729	86720	86721	86722	86723	86724
Weight Per Thousand (lbs.)	.44	.62	1.04	1.50	2.32	2.72
See Website for Pricing						
Hammered Nickered	86779	86770	86771	86772	86773	86774
Weight Per Thousand (lbs.)	.38	.56	1.04	1.37	2.09	2.49
See Website for Pricing						

Packaging: Bulk, Polybagged

Quantity Discounts (per size): 5M-9M less 5%, 10M-24M less 10%, 25M-49M less 15%, 50M-99M less 20% 100M-Over less 25%

Indiana Steel Blades - Painted One Side

Size	2	3	4	5
Product Number	7P201	7P301	7P401	7P501
Call for Pricing				

Size	6	7	8	9
Product Number	7P601	7P701	7P801	7P901
Call for Pricing				

Prices stated refer to smooth blades and apply to orders of 1,000 pieces (per size and finish)

Painted blades are not stock items. Please allow 2-3 weeks for delivery.



WARNING: This product can expose you to chemicals including nickel and lead, which are known to the State of California to cause cancer and birth defects or other reproductive harm. For more information, visit www.P65Warnings.ca.gov



Indiana - Steel



Approximate Size

Indiana Steel Blades

Size	5	6	7	8	9
Length (in.)	1.328	1.590	1.850	2.125	2.375
Width (in.)	.728	.888	1.040	1.202	1.344
Hole Diameter (in.)	.096	.116	.136	.156	.156
Thickness (in.)	.018	.018	.018	.018	.018
Smooth Nickerled	86725	86726	86727	86728	86739
Weight Per Thousand (lbs.)	3.87	5.40	7.38	7.47	7.47
See Website for Pricing					
Hammered Nickerled	86775	86776	86777	86778	86789
Weight Per Thousand (lbs.)	3.70	5.40	7.38	7.47	12.10
See Website for Pricing					

Packaging: Bulk, Polybagged

Quantity Discounts (per size): 5M-9M less 5%, 10M-24M less 10%, 25M-49M less 15%, 50M-99M less 20% 100M-Over less 25%

Indiana Steel Blades - Painted Two Sides

Size	2	3	4	5
Product Number	7P202	7P302	7P402	7P502
Call for Pricing				

Size	6	7	8	9
Product Number	7P602	7P702	7P802	7P902
Call for Pricing				

Prices stated refer to smooth blades and apply to orders of 1,000 pieces (per size and finish)

Painted blades are not stock items. Please allow 2-3 weeks for delivery.



WARNING: This product can expose you to chemicals including nickel and lead, which are known to the State of California to cause cancer and birth defects or other reproductive harm. For more information, visit www.P65Warnings.ca.gov



Magnum

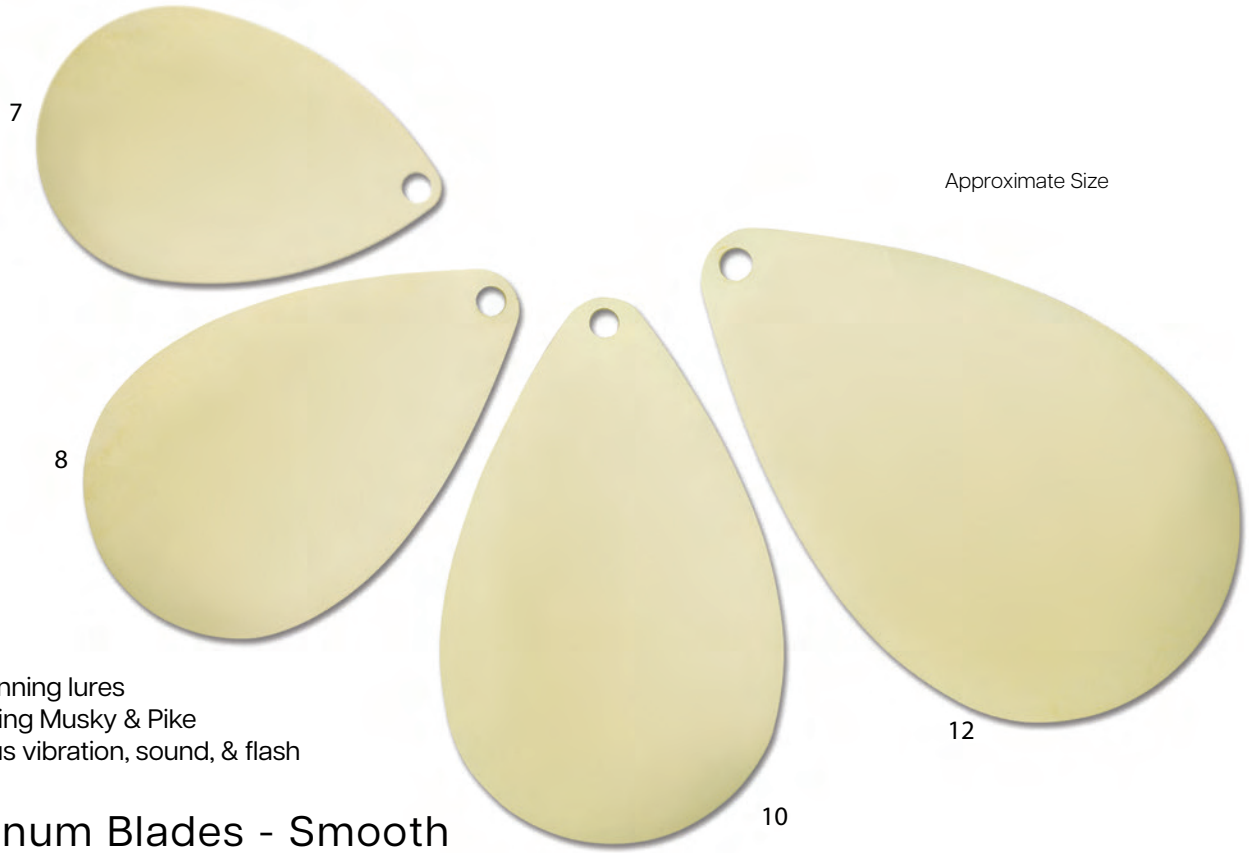

Approximate Size

- Ideal for large spinning lures
- Perfect for targeting Musky & Pike
- Creates enormous vibration, sound, & flash

Magnum Blades - Smooth

Size	7	8	10	10	12
Length (in.)	2.135	2.599	2.888	2.888	3.321
Width (in.)	1.440	1.621	1.805	1.805	2.075
Hole Diameter (in.)	.152	.154	.152	.150	.172
Thickness (in.)	.025	.025	.025	.040	.025
Weight Per Thousand (lbs.)	17.20	23.86	29.81	45.90	39.62
Plain Brass	85540	85400	85500	85600	85700
Call for Pricing					
Polished Brass	85550	85410	85510	85610	85710
See Website for Pricing					
Polished Brass Lacquered	85570	85430	85530	85630	85730
See Website for Pricing					
Nickled	85560	85420	85520	85620	85720
See Website for Pricing					

Packaging: Bulk, Polybagged

Quantity Discounts (per size): 5M-9M less 5%, 10M-24M less 10%, 25M-49M less 15%, 50M-99M less 20% 100M-Over less 25%

Magnum Blades - Painted One Side

Size	8	10 (.025 thickness)	12
Product Number	7R801	7RA01	7RR01
Call for Pricing			

Magnum Blades - Painted Two Sides

Size	8	10 (.025 thickness)	12
Product Number	7R802	7RA02	7RR02
Call for Pricing			

Prices stated refer to smooth blades and apply to orders of 250 pieces (per size and finish). Painted blades are not stock items. Please allow 2-3 weeks for delivery.



WARNING: This product can expose you to chemicals including nickel and lead, which are known to the State of California to cause cancer and birth defects or other reproductive harm. For more information, visit www.P65Warnings.ca.gov

www.worthco.com sales@worthco.com



Magnum

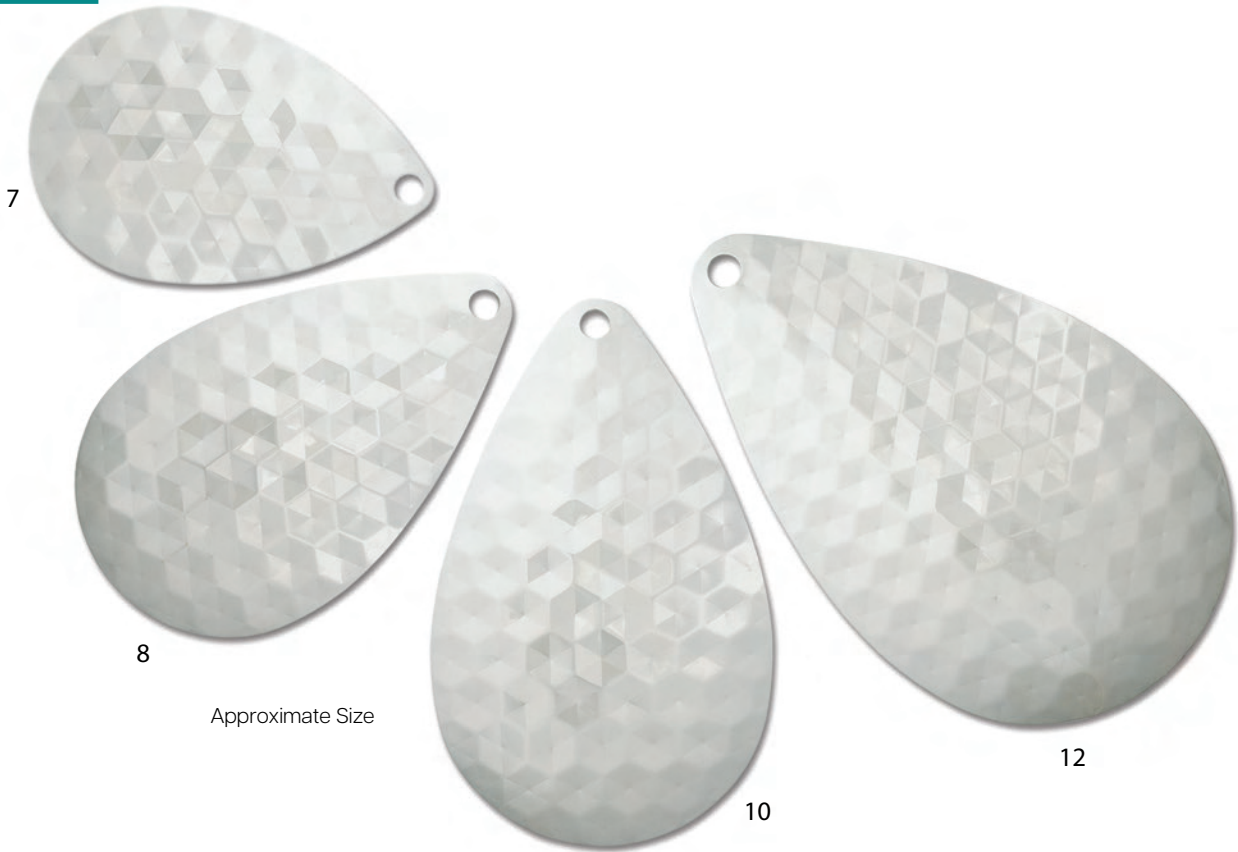

Approximate Size

Magnum Blades - Hex

Size	7	8	10	12
Length (in.)	2.135	2.599	2.888	3.321
Width (in.)	1.440	1.620	1.805	2.075
Hole Diameter (in.)	.152	.152	.152	.174
Thickness (in.)	.025	.025	.025	.025
Weight Per Thousand (lbs.)	17.97	23.53	29.81	39.62
Plain Brass	85240	85200	85300	85800
Call for Pricing				
Polished Brass	85250	85210	85310	85810
See Website for Pricing				
Polished Brass Lacquered	85270	85230	85330	85830
See Website for Pricing				
Nickled	85260	85220	85320	85820
See Website for Pricing				

Packaging: Bulk, Polybagged

Quantity Discounts (per size): 5M-9M less 5%, 10M-24M less 10%, 25M-49M less 15%, 50M-99M less 20% 100M-Over less 25%



WARNING: This product can expose you to chemicals including nickel and lead, which are known to the State of California to cause cancer and birth defects or other reproductive harm. For more information, visit www.P65Warnings.ca.gov



French



- Most popular spinner blade for inline spinners
- Great for targeting panfish, trout, & bass
- Easy to engage & keep spinning
- Intermediate running depth
- High Vibration

French Blades - Smooth

Size	0	1	2	3	4
Length (in.)	.736	.866	1.050	1.264	1.510
Width (in.)	.434	.484	.574	.704	.742
Hole Diameter (in.)	.077	.094	.093	.115	.124
Thickness (in.)	.025	.025	.025	.025	.025
Weight Per Thousand (lbs.)	1.89	2.56	3.59	5.21	6.61
Plain Brass	93510	93511	93512	93513	93514
Call for Pricing					
Polished Brass	93520	93521	93522	93523	93524
See Website for Pricing					
Polished Brass Lacquered	93590	93591	93592	93593	93594
See Website for Pricing					
Nickeled	93530	93531	93532	93533	93534
See Website for Pricing					
Gold Plate	93540	93541	93542	93543	93544
Call for Pricing					

Packaging: Bulk, Polybagged

Quantity Discounts (per size): 5M-9M less 5%, 10M-24M less 10%, 25M-49M less 15%, 50M-99M less 20% 100M-Over less 25%

Discounts not available on gold.



WARNING: This product can expose you to chemicals including nickel and lead, which are known to the State of California to cause cancer and birth defects or other reproductive harm. For more information, visit www.P65Warnings.ca.gov



French



5



6



7



8

Approximate Size

French Blades - Smooth

Size	5	6	7	8
Length (in.)	1.742	1.970	2.250	2.500
Width (in.)	.816	.890	.973	1.125
Hole Diameter (in.)	.124	.138	.155	.153
Thickness (in.)	.025	.025	.032	.032
Weight Per Thousand (lbs.)	8.73	10.85	16.86	21.58
Plain Brass	93515	93516	93517	93518
Call for Pricing				
Polished Brass	93525	93526	93527	93528
See Website for Pricing	\$209.30	\$270.90	\$415.30	\$535.90
Polished Brass Lacquered	93595	93596	93597	93598
See Website for Pricing				
Nickel	93535	93536	93537	93538
See Website for Pricing				
Gold Plate	93545	93546	93547	93548
Call for Pricing				

Packaging: Bulk, Polybagged

Quantity Discounts (per size): 5M-9M less 5%, 10M-24M less 10%, 25M-49M less 15%, 50M-99M less 20%, 100M-Over less 25% **Discounts not available on gold.**



WARNING: This product can expose you to chemicals including nickel and lead, which are known to the State of California to cause cancer and birth defects or other reproductive harm. For more information, visit www.P65Warnings.ca.gov



French

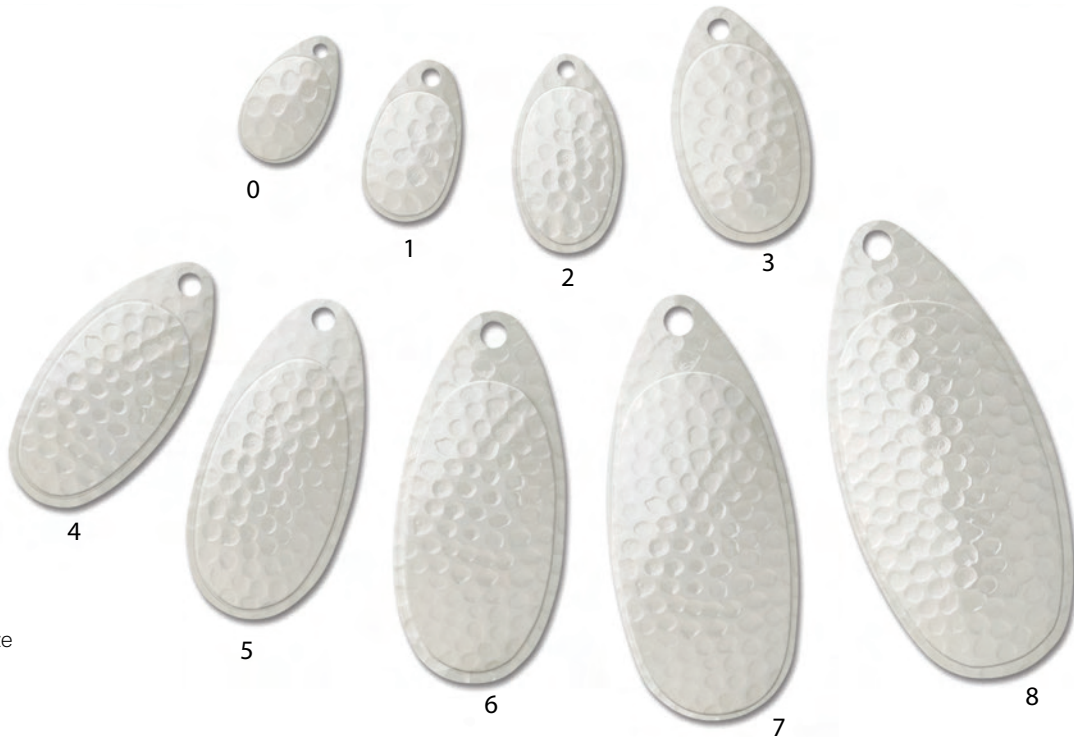

Approximate Size

French Blades - Hammered

Size	0	1	2	3	4	5	6	7	8
Length (in.)	.736	.866	1.050	1.264	1.510	1.742	1.970	2.250	2.500
Width (in.)	.434	.484	.574	.704	.742	.816	.890	.973	1.125
Hole Diameter (in.)	.077	.094	.093	.115	.124	.124	.138	.155	.153
Thickness (in.)	.025	.025	.025	.025	.025	.025	.025	.032	.032
Weight Per Thousand (lbs.)	1.87	2.48	3.53	5.13	6.61	8.49	10.53	16.86	21.49
Plain Brass	83510	83511	83512	83513	83514	83515	83516	83517	83518
Call for Pricing									
Polished Brass	83520	83521	83522	83523	83524	83525	83526	83527	83528
See Website for Pricing									
Polished Brass Lacquered	83540	83541	83542	83543	83544	83545	83546	83547	83548
See Website for Pricing									
Nickel	83530	83531	83532	83533	83534	83535	83536	83537	83538
See Website for Pricing									
Gold Plate	83500	83501	83502	83503	83504	83505	83506	83507	83508
Call for Pricing									

Packaging: Bulk, Polybagged

Quantity Discounts (per size): 5M-9M less 5%, 10M-24M less 10%, 25M-49M less 15%, 50M-99M less 20% 100M-Over less 25%

Discounts not available on gold.



WARNING: This product can expose you to chemicals including nickel and lead, which are known to the State of California to cause cancer and birth defects or other reproductive harm. For more information, visit www.P65Warnings.ca.gov



French

Painted Items

See our Custom Colors section starting on **page 115** for information on painted items



French Blades - Painted One Side

Size	0	1	2	3	4	5	6	7	8
Product Number	74001	74101	74201	74301	74401	74501	74601	74701	74801
Call for Pricing									

French Blades - Painted Two Sides

Size	0	1	2	3	4	5	6	7	8
Product Number	74002	74102	74202	74302	74402	74502	74602	74702	74802
Call for Pricing									

Note: All painted blades are brass material.

Prices stated refer to smooth blades and apply to orders of 1,000 pieces (per size and finish)

Painted blades are not stock items. Please allow 2-3 weeks for delivery.



WARNING: This product can expose you to chemicals including nickel and lead, which are known to the State of California to cause cancer and birth defects or other reproductive harm. For more information, visit www.P65Warnings.ca.gov



Fluted

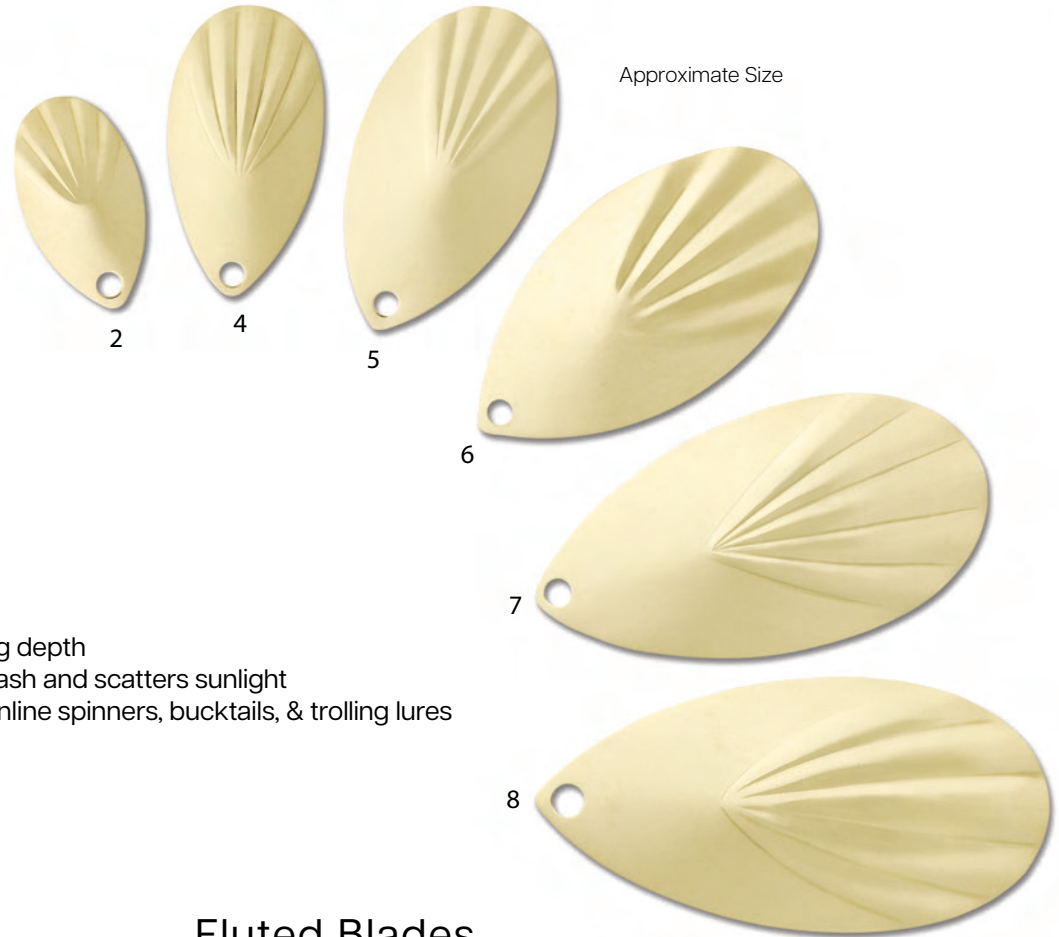

- Intermediate running depth
- Fluted design add flash and scatters sunlight
- Effective option for inline spinners, bucktails, & trolling lures

Fluted Blades

Size	2	4	5	6	7	8
Length (in.)	1.144	1.515	1.800	2.114	2.420	2.669
Width (in.)	.630	.814	.972	1.114	1.267	1.312
Hole Diameter (in.)	.125	.124	.125	.130	.156	.163
Thickness (in.)	.018	.018	.018	.018	.018	.025
Weight Per Thousand (lbs.)	3.12	5.27	7.27	9.94	13.44	20.50
Plain Brass	95612	95614	95615	95616	95617	95618
Call for Pricing						
Polished Brass	95622	95624	95625	95626	95627	95628
See Website for Pricing						
Nickeled	95632	95634	95635	95636	95637	95638
See Website for Pricing						

Packaging: Bulk, Polybagged

Quantity Discounts (per size): 5M-9M less 5%, 10M-24M less 10%, 25M-49M less 15%, 50M-99M less 20% 100M-Over less 25%



WARNING: This product can expose you to chemicals including nickel and lead, which are known to the State of California to cause cancer and birth defects or other reproductive harm. For more information, visit www.P65Warnings.ca.gov



Fluted

Painted Items

See our Custom Colors section starting on **page 115** for information on painted items



Fluted Blades - Painted One Side

Size	2	4	5	6	7	8
Product Number	73201	73401	73501	73601	73701	73801
Call for Pricing						

Fluted Blades - Painted Two Sides

Size	2	4	5	6	7	8
Product Number	73202	73402	73502	73602	73702	73802
Call for Pricing						

Note: All painted blades are brass material.

Prices stated refer to smooth blades and apply to orders of 1,000 pieces (per size and finish)

Painted blades are not stock items. Please allow 2-3 weeks for delivery.



WARNING: This product can expose you to chemicals including nickel and lead, which are known to the State of California to cause cancer and birth defects or other reproductive harm. For more information, visit www.P65Warnings.ca.gov



Willowleaf

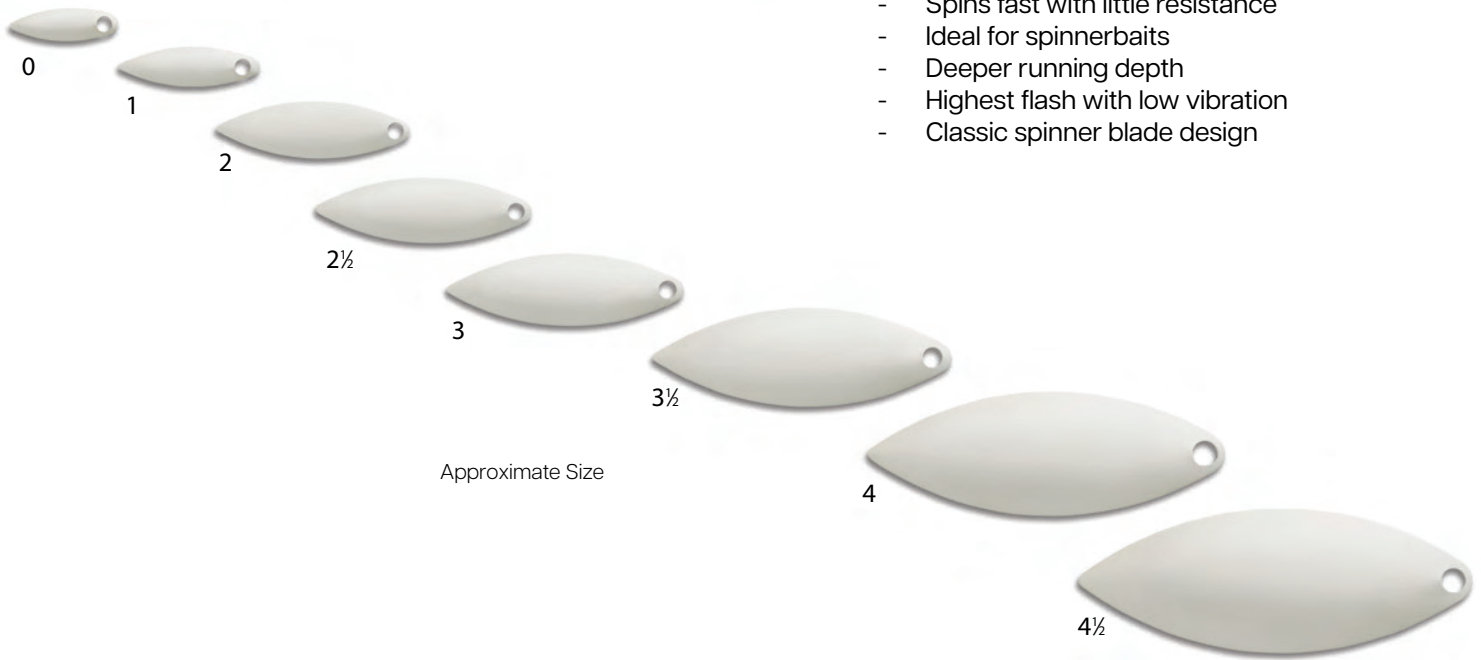

- Spins fast with little resistance
- Ideal for spinnerbaits
- Deeper running depth
- Highest flash with low vibration
- Classic spinner blade design

Willowleaf Blades - Smooth

Size	0	1	2	2 ½	3	3 ½
Length (in.)	.568	.744	1.016	1.128	1.240	1.562
Width (in.)	.172	.208	.296	.340	.376	.511
Hole Diameter (in.)	.075	.077	.080	.079	.087	.100
Thickness (in.)	.012	.014	.018	.018	.018	.018
Weight Per Thousand (lbs.)	.28	.50	1.16	1.54	1.87	3.20
Plain Brass	94800	94801	94802	95150	94803	94808
Call for Pricing						
Polished Brass	94810	94811	94812	95151	94813	94818
See Website for Pricing						
Polished Brass Lacquered	94040	94041	94042	95152	94043	94048
See Website for Pricing						
Nickeled	94820	94821	94822	95155	94823	94828
See Website for Pricing						
Gold Plate	94830	94831	94832	95156	94833	94838
Call for Pricing						

Packaging: Bulk, Polybagged

Quantity Discounts (per size): 5M-9M less 5%, 10M-24M less 10%, 25M-49M less 15%, 50M-99M less 20% 100M-Over less 25%
Discounts not available on gold.



WARNING: This product can expose you to chemicals including nickel and lead, which are known to the State of California to cause cancer and birth defects or other reproductive harm. For more information, visit www.P65Warnings.ca.gov



Willowleaf

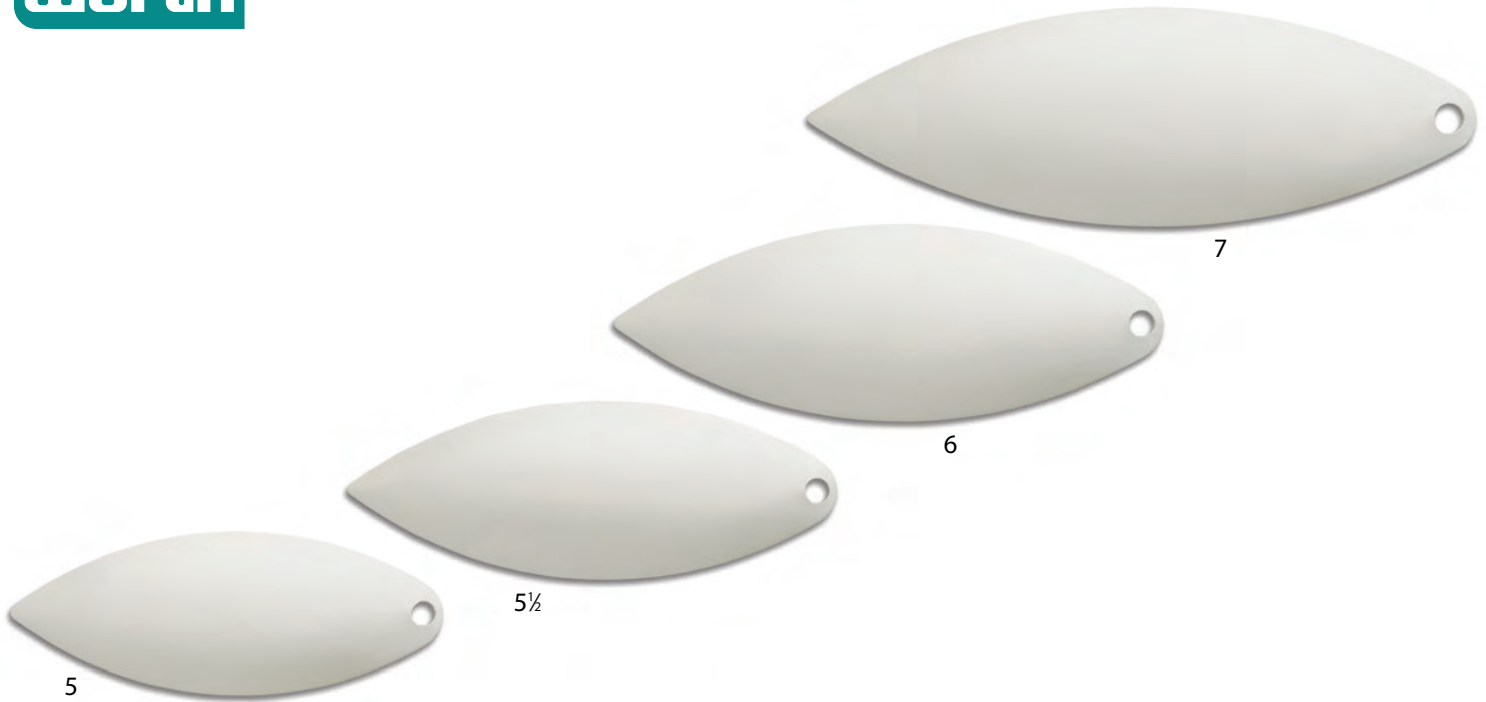

Willowleaf Blades - Smooth

Size	4	4 1/2	5	5 1/2	6	7
Length (in.)	1.872	2.062	2.260	2.562	2.875	3.500
Width (in.)	.653	.755	.850	.930	1.015	1.125
Hole Diameter (in.)	.125	.121	.122	.123	.150	.150
Thickness (in.)	.018	.018	.020	.020	.020	.020
Weight Per Thousand (lbs.)	4.85	6.06	8.60	10.69	13.06	17.36
Plain Brass	94804	95130	94805	94809	94806	94807
Call for Pricing						
Polished Brass	94814	95131	94815	94819	94816	94817
See Website for Pricing						
Polished Brass Lacquered	94044	95132	94045	94049	94046	94047
See Website for Pricing						
Nickeled	94824	95135	94825	94829	94826	94827
See Website for Pricing						
Gold Plate	94834	95136	94835	94839	94836	94837
Call for Pricing						

Packaging: Bulk, Polybagged

Quantity Discounts (per size): 5M-9M less 5%, 10M-24M less 10%, 25M-49M less 15%, 50M-99M less 20% 100M-Over less 25%

Discounts not available on gold.



WARNING: This product can expose you to chemicals including nickel and lead, which are known to the State of California to cause cancer and birth defects or other reproductive harm. For more information, visit www.P65Warnings.ca.gov

www.worthco.com

sales@worthco.com



Willowleaf

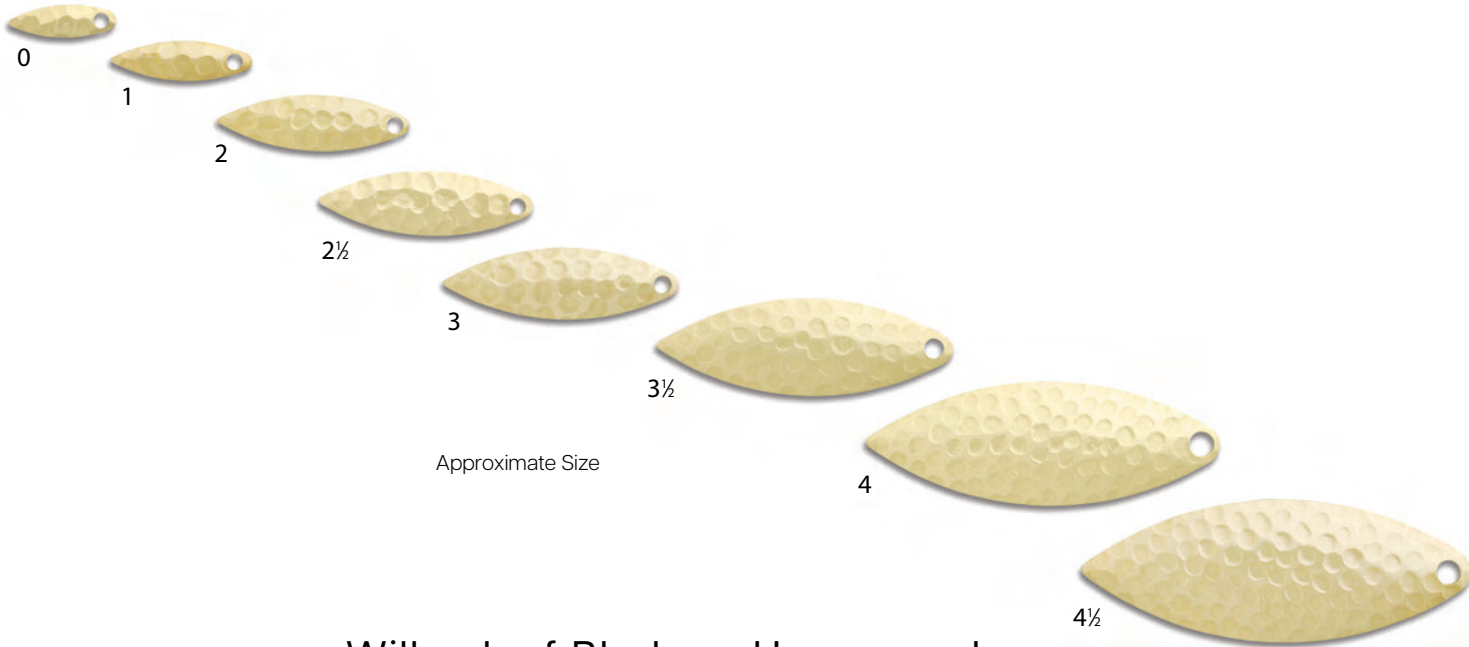

Willowleaf Blades - Hammered

Size	0	1	2	2 1/2	3	3 1/2
Length (in.)	.568	.744	1.016	1.128	1.240	1.562
Width (in.)	.172	.208	.296	.340	.376	.511
Hole Diameter (in.)	.076	.080	.081	.080	.086	.101
Thickness (in.)	.012	.014	.018	.018	.018	.018
Weight Per Thousand (lbs.)	0.28	0.44	1.10	1.43	1.71	2.98
Plain Brass	94850	94851	94852	95160	94853	94858
Call for Pricing						
Polished Brass	94860	94861	94862	95161	94863	94868
See Website for Pricing						
Polished Brass Lacquered	94050	94051	94052	95162	94053	94058
See Website for Pricing						
Nickeled	94870	94871	94872	95165	94873	94878
See Website for Pricing						
Gold Plate	94880	94881	94882	95166	94883	94888
Call for Pricing						

Packaging: Bulk, Polybagged

Quantity Discounts (per size): 5M-9M less 5%, 10M-24M less 10%, 25M-49M less 15%, 50M-99M less 20% 100M-Over less 25%
Discounts not available on gold.



WARNING: This product can expose you to chemicals including nickel and lead, which are known to the State of California to cause cancer and birth defects or other reproductive harm. For more information, visit www.P65Warnings.ca.gov



Willowleaf

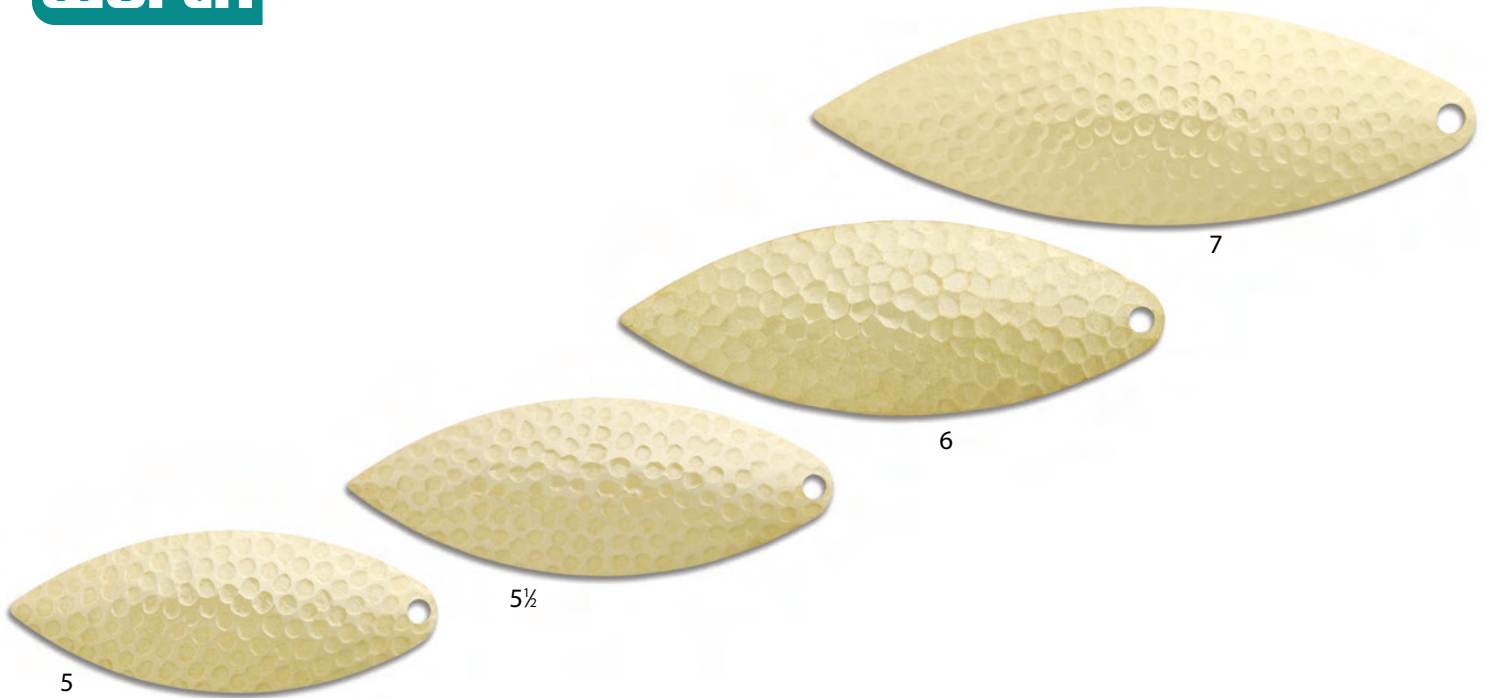

Willowleaf Blades - Hammered

Size	4	4 1/2	5	5 1/2	6	7
Length (in.)	1.872	2.062	2.260	2.562	2.875	3.500
Width (in.)	.653	.755	.850	.930	1.015	1.125
Hole Diameter (in.)	.126	.120	.122	.124	.150	.150
Thickness (in.)	.018	.018	.020	.020	.020	.020
Weight Per Thousand (lbs.)	4.46	6.28	8.05	9.94	12.46	16.80
Plain Brass	94854	95140	94855	94859	94856	94857
Call for Pricing						
Polished Brass	94864	95141	94865	94869	94866	94867
See Website for Pricing						
Polished Brass Lacquered	94054	95142	94055	94059	94056	94057
See Website for Pricing						
Nickel	94874	95145	94875	94879	94876	94877
See Website for Pricing						
Gold Plate	94884	95146	94885	94889	94886	94887
Call for Pricing						

Packaging: Bulk, Polybagged

Quantity Discounts (per size): 5M-9M less 5%, 10M-24M less 10%, 25M-49M less 15%, 50M-99M less 20% 100M-Over less 25%
Discounts not available on gold.



WARNING: This product can expose you to chemicals including nickel and lead, which are known to the State of California to cause cancer and birth defects or other reproductive harm. For more information, visit www.P65Warnings.ca.gov



Willowleaf

Painted Items

See our Custom Colors section starting on **page 115** for information on painted items



Willowleaf Blades - Painted One Side

Size	2	2 ½	3	3 ½	4
Product Number	7C201	7CG01	7C301	7CJ01	7C401
Call for Pricing					

Size	4 ½	5	5 ½	6	7
Product Number	7CK01	7C501	7CL01	7C601	7C701
Call for Pricing					

Willowleaf Blades - Painted Two Sides

Size	2	2 ½	3	3 ½	4
Product Number	7C202	7CG02	7C302	7CJ02	7C402
Call for Pricing					

Size	4 ½	5	5 ½	6	7
Product Number	7CK02	7C502	7CL02	7C602	7C702
Call for Pricing					

Note: All painted blades are brass material.

Prices stated refer to smooth blades and apply to orders of 1,000 pieces (per size and finish)

Painted blades are not stock items. Please allow 2-3 weeks for delivery.



WARNING: This product can expose you to chemicals including nickel and lead, which are known to the State of California to cause cancer and birth defects or other reproductive harm. For more information, visit www.P65Warnings.ca.gov



Willowleaf - Steel

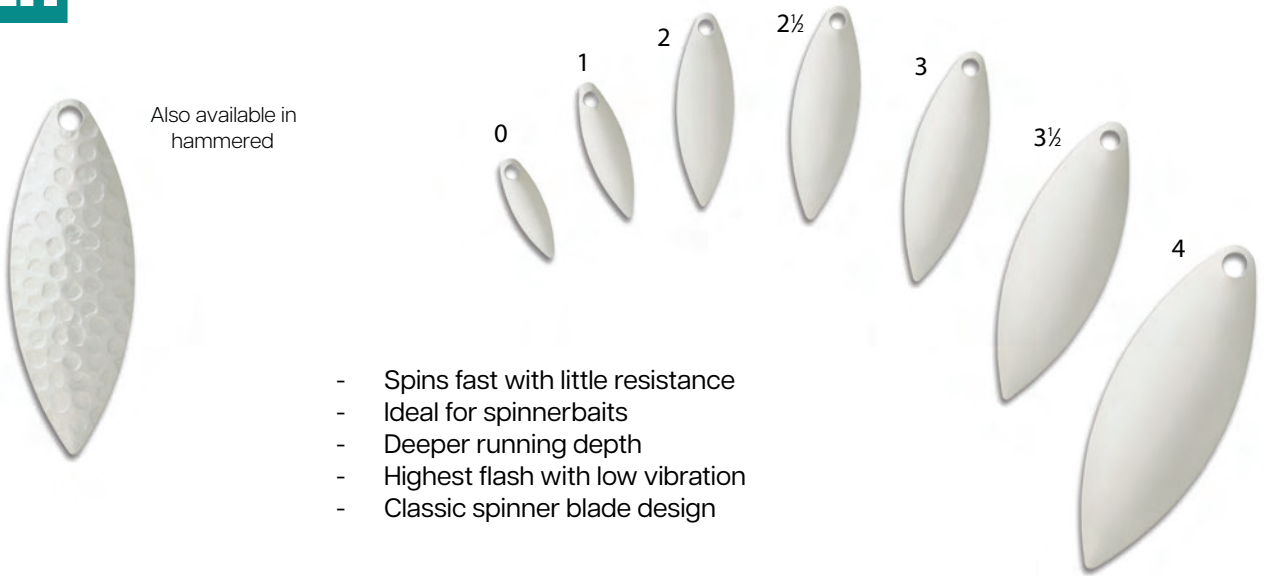

Willowleaf Steel Blades

Size	0	1	2	2 1/2	3	3 1/2
Length (in.)	.568	.744	1.016	1.128	1.240	1.562
Width (in.)	.172	.208	.296	.340	.376	.511
Hole Diameter (in.)	.075	.077	.080	.079	.087	.100
Thickness (in.)	.015	.015	.018	.018	.018	.018
Smooth Nickeled	86820	86821	86822	86833	86823	86828
Weight Per Thousand (lbs.)	.34	.56	1.23	1.32	1.87	2.92
See Website for Pricing						
Hammered Nickeled	86870	86871	86872	86883	86873	86878
Weight Per Thousand (lbs.)	.32	.45	1.00	1.32	1.60	2.72
See Website for Pricing						

Packaging: Bulk, Polybagged

Quantity Discounts (per size): 5M-9M less 5%, 10M-24M less 10%, 25M-49M less 15%, 50M-99M less 20% 100M-Over less 25%

Willowleaf Steel Blades - Painted One Side

Size	2	2 1/2	3	3 1/2	4
Product Number	7N201	7NG01	7N301	7NJ01	7N401
Call for Pricing					

Size	4 1/2	5	5 1/2	6	7
Product Number	7NK01	7N501	7NL01	7N601	7N701
Call for Pricing					

Prices stated refer to smooth blades and apply to orders of 1,000 pieces (per size and finish).

Painted blades are not stock items. Please allow 2-3 weeks for delivery.



WARNING: This product can expose you to chemicals including nickel and lead, which are known to the State of California to cause cancer and birth defects or other reproductive harm. For more information, visit www.P65Warnings.ca.gov



Willowleaf - Steel



Willowleaf Steel Blades

Size	4	4 1/2	5	5 1/2	6	7
Length (in.)	1.872	2.062	2.260	2.562	2.875	3.500
Width (in.)	.653	.755	.850	.930	1.015	1.125
Hole Diameter (in.)	.125	.121	.122	.123	.150	.150
Thickness (in.)	.018	.018	.018	.018	.018	.018
Smooth Nickeled	86824	86835	86825	86829	86826	86827
Weight Per Thousand (lbs.)	4.52	5.79	7.10	8.89	10.86	14.44
See Website for Pricing						
Hammered Nickeled	86874	86845	86875	86879	86876	86877
Weight Per Thousand (lbs.)	4.30	5.27	7.10	8.89	10.85	14.43
See Website for Pricing						

Packaging: Bulk, Polybagged

Quantity Discounts (per size): 5M-9M less 5%, 10M-24M less 10%, 25M-49M less 15%, 50M-99M less 20% 100M-Over less 25%

Willow Steel Blades - Painted Two Sides

Size	2	2 1/2	3	3 1/2	4
Product Number	7N202	7NG02	7N302	7NJ02	7N402
Call for Pricing					

Prices stated refer to smooth blades and apply to orders of 1,000 pieces (per size and finish).

Size	4 1/2	5	5 1/2	6	7
Product Number	7NK02	7N502	7NL02	7N602	7N702
Call for Pricing					

Painted blades are not stock items. Please allow 2-3 weeks for delivery.



WARNING: This product can expose you to chemicals including nickel and lead, which are known to the State of California to cause cancer and birth defects or other reproductive harm. For more information, visit www.P65Warnings.ca.gov



Willowleaf - Aspen

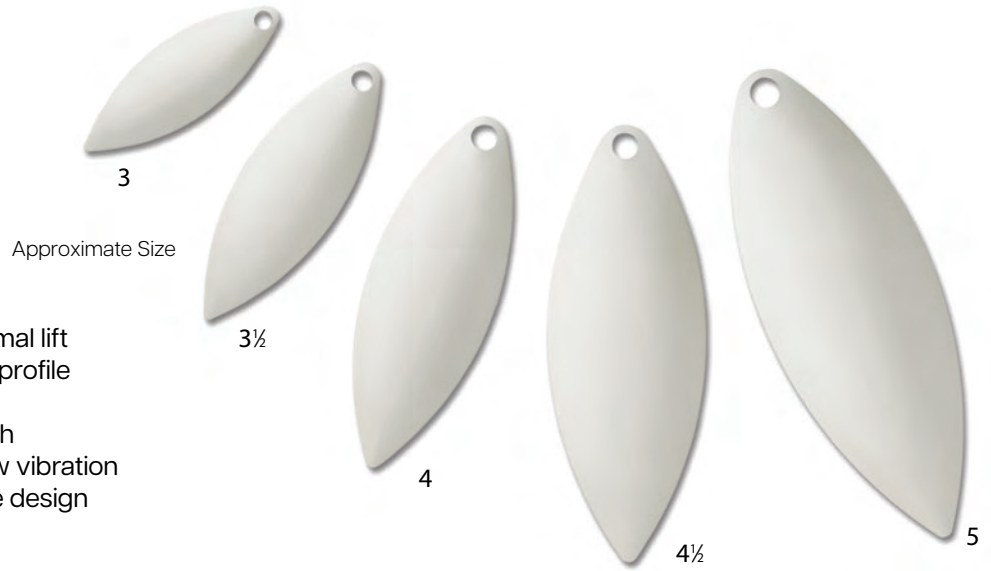

- Spins tight with minimal lift
- Narrower Willowleaf profile
- Ideal for spinnerbaits
- Deeper running depth
- Highest flash with low vibration
- Classic spinner blade design

Willowleaf Aspen Smooth Blades

Size	3	3 1/2	4	4 1/2	5
Length (in.)	1.225	1.575	1.917	2.280	2.622
Width (in.)	.420	.540	.680	.822	.934
Hole Diameter (in.)	.094	.108	.134	.134	.156
Thickness (in.)	.018	.018	.018	.018	.020
Weight Per Thousand (lbs.)	2.00	3.30	5.110	7.320	10.700
Plain Brass	9A303	9A307	9A304	9A308	9A305
Call for Pricing					
Polished Brass	9A313	9A317	9A314	9A318	9A315
See Website for Pricing					
Polished Brass Lacquer	9A343	9A347	9A344	9A348	9A345
See Website for Pricing					
Nickel	9A323	9A327	9A324	9A328	9A325
See Website for Pricing					
Gold Plate	9A333	9A337	9A334	9A338	9A335
Call for Pricing					

Packaging: Bulk, Polybagged

Quantity Discounts (per size): 5M-9M less 5%, 10M-24M less 10%, 25M-49M less 15%, 50M-99M less 20%, 100M-Over less 25% **Discounts not available on gold.**



WARNING: This product can expose you to chemicals including nickel and lead, which are known to the State of California to cause cancer and birth defects or other reproductive harm. For more information, visit www.P65Warnings.ca.gov



Willowleaf - Aspen

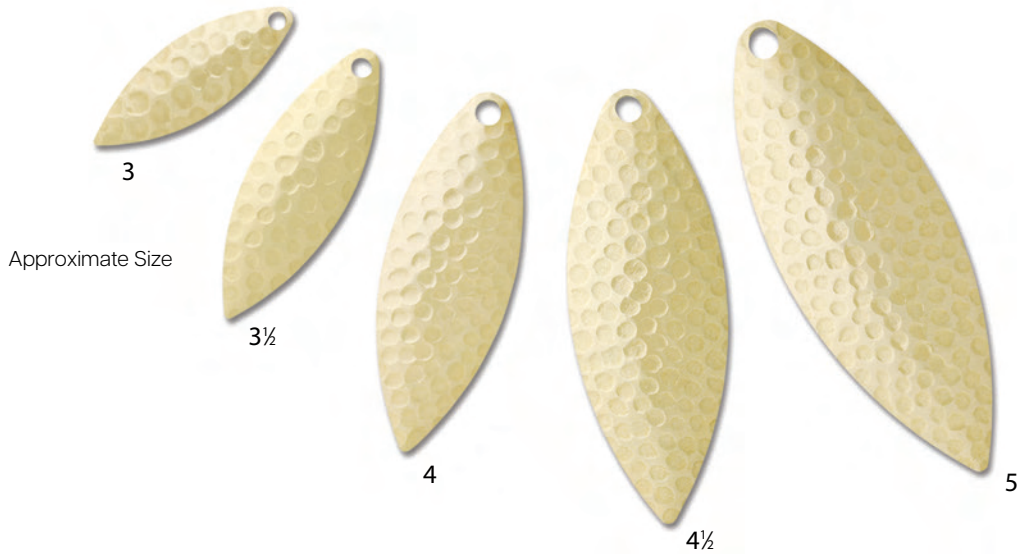

Willowleaf Aspen Hammered Blades

Size	3	3 1/2	4	4 1/2	5
Length (in.)	1.225	1.575	1.917	2.280	2.622
Width (in.)	.420	.540	.680	.822	.934
Hole Diameter (in.)	.094	.108	.134	.134	.156
Thickness (in.)	.018	.018	.018	.018	.020
Weight Per Thousand (lbs.)	2.00	3.30	5.110	7.320	10.700
Plain Brass	9A353	9A357	9A354	9A358	9A355
Call for Pricing					
Polished Brass	9A363	9A367	9A364	9A368	9A365
See Website for Pricing					
Polished Brass Lacquer	9A393	9A397	---	9A398	9A395
See Website for Pricing			---		
Nickeled	9A373	9A377	9A374	9A378	9A375
See Website for Pricing					
Gold Plate	9A383	9A387	9A384	9A388	9A385
Call for Pricing					

Packaging: Bulk, Polybagged

Quantity Discounts (per size): 5M-9M less 5%, 10M-24M less 10%, 25M-49M less 15%, 50M-99M less 20%, 100M-Over less 25% **Discounts not available on gold.**



WARNING: This product can expose you to chemicals including nickel and lead, which are known to the State of California to cause cancer and birth defects or other reproductive harm. For more information, visit www.P65Warnings.ca.gov



Willowleaf - Aspen

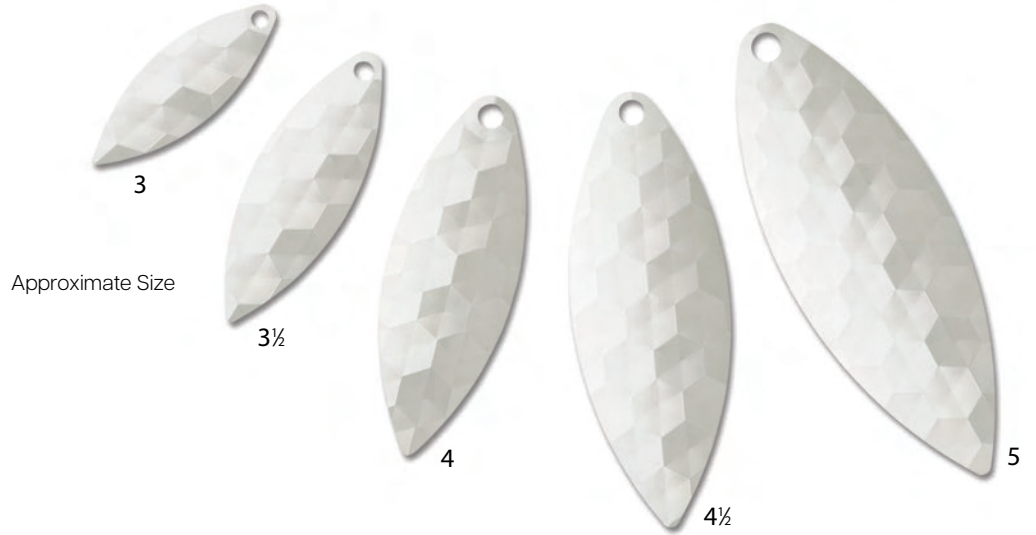

Willowleaf Aspen Hex Blades

Size	3	3 1/2	4	4 1/2	5
Length (in.)	1.225	1.575	1.917	2.280	2.622
Width (in.)	.420	.540	.680	.822	.934
Hole Diameter (in.)	.094	.108	.134	.134	.156
Thickness (in.)	.018	.018	.018	.018	.020
Weight Per Thousand (lbs.)	2.00	3.30	5.110	7.320	10.700
Plain Brass	9A403	9A407	9A404	9A408	9A405
Call for Pricing					
Polished Brass	9A413	9A417	9A414	9A418	9A415
See Website for Pricing					
Polished Brass Lacquer	9A443	9A447	9A444	9A448	9A445
See Website for Pricing					
Nickeled	9A423	9A427	9A424	9A428	9A425
See Website for Pricing					
Gold Plate	9A433	9A437	9A434	9A438	9A435
Call for Pricing					

Packaging: Bulk, Polybagged

Quantity Discounts (per size): 5M-9M less 5%, 10M-24M less 10%, 25M-49M less 15%, 50M-99M less 20%, 100M-Over less 25% **Discounts not available on gold.**



WARNING: This product can expose you to chemicals including nickel and lead, which are known to the State of California to cause cancer and birth defects or other reproductive harm. For more information, visit www.P65Warnings.ca.gov



Willowleaf - Aspen - Steel

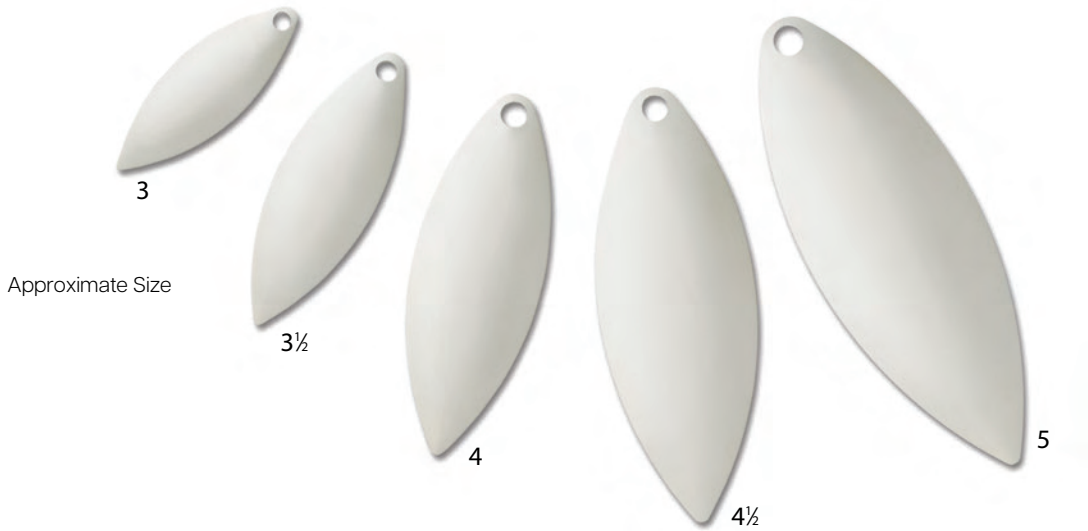

Willowleaf Aspen Steel Blades

Size	3	3 1/2	4	4 1/2	5
Length (in.)	1.225	1.575	1.917	2.280	2.622
Width (in.)	.420	.540	.680	.822	.934
Hole Diameter (in.)	.094	.108	.134	.134	.156
Thickness (in.)	.018	.018	.018	.018	.020
Weight Per Thousand (lbs.)	1.84	3.03	4.69	6.72	8.92
Nickel	8A313	8A317	8A314	8A318	8A315
See Website for Pricing					

Packaging: Bulk, Polybagged

Quantity Discounts (per size): 5M-9M less 5%, 10M-24M less 10%, 25M-49M less 15%, 50M-99M less 20%, 100M-Over less 25%



WARNING: This product can expose you to chemicals including nickel and lead, which are known to the State of California to cause cancer and birth defects or other reproductive harm. For more information, visit www.P65Warnings.ca.gov



Willowleaf - Shallow Cup

- Spins fast with little resistance at low speeds
- Ideal for spinnerbaits
- Broader spin with increased flash
- Classic spinner blade design

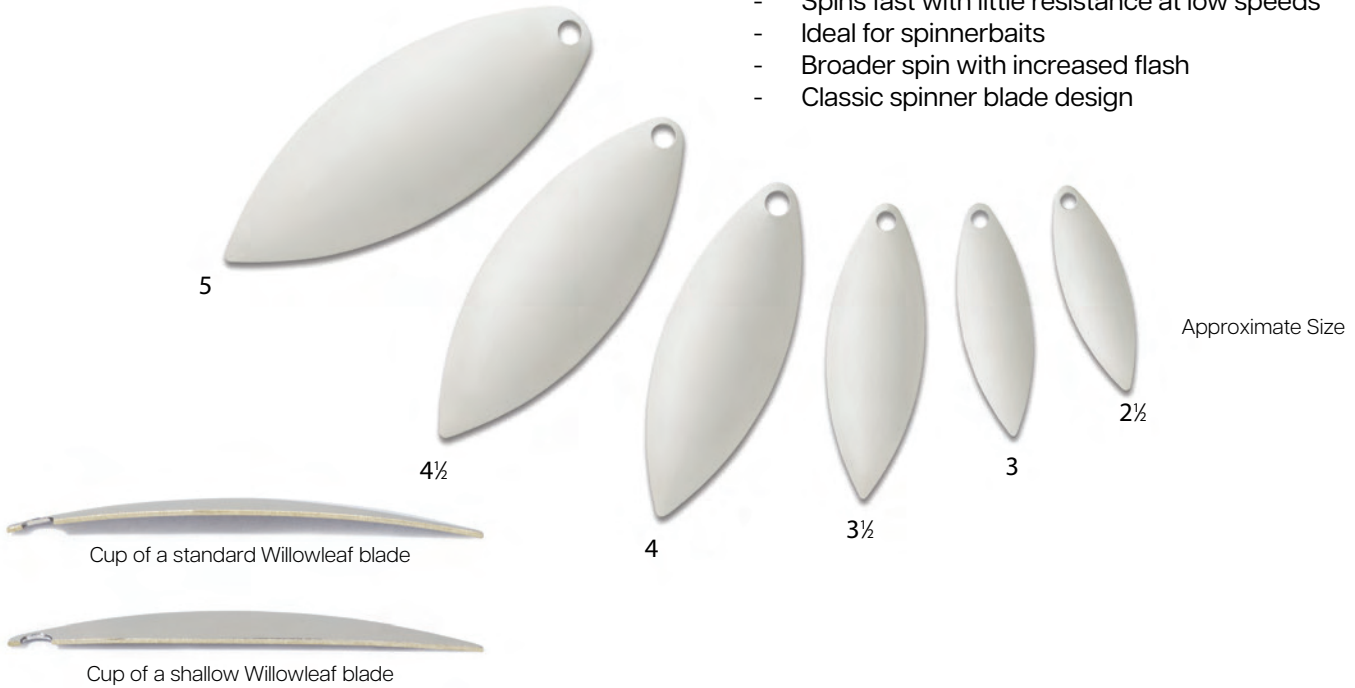

Willowleaf Blades Shallow Cup - Smooth

Size	2 1/2	3	3 1/2	4	4 1/2	5
Length (in.)	1.128	1.240	1.562	1.872	2.062	2.260
Width (in.)	.340	.376	.511	.653	.753	.852
Hole Diameter (in.)	.081	.088	.099	.128	.123	.122
Thickness (in.)	.018	.018	.018	.018	.018	.020
Weight Per Thousand (lbs.)	1.49	1.82	3.09	4.80	6.00	8.57
Plain Brass	85150	84803	84808	84804	85130	84805
Call for Pricing						
Polished Brass	85151	84813	84818	84814	85131	84815
See Website for Pricing						
Polished Brass Lacquered	85152	84043	84048	84044	85132	84045
See Website for Pricing						
Nickeled	85155	84823	84828	84824	85135	84825
See Website for Pricing						
Gold Plate	85156	84833	84838	84834	85136	84835
Call for Pricing						

Packaging: Bulk, Polybagged

Quantity Discounts (per size): 5M-9M less 5%, 10M-24M less 10%, 25M-49M less 15%, 50M-99M less 20% 100M-Over less 25%

Discounts not available on gold.



WARNING: This product can expose you to chemicals including nickel and lead, which are known to the State of California to cause cancer and birth defects or other reproductive harm. For more information, visit www.P65Warnings.ca.gov

www.worthco.com

sales@worthco.com



Willowleaf - Shallow Cup

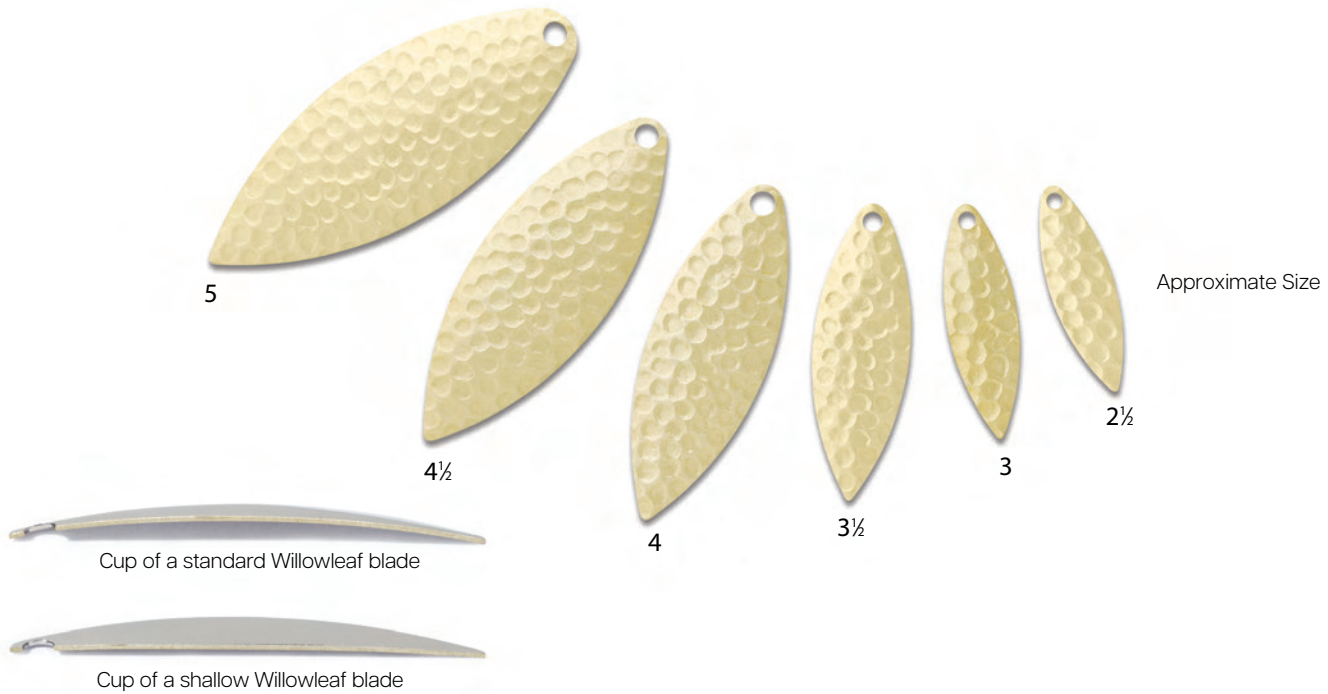

Willowleaf Blades Shallow Cup - Hammered

Size	2 1/2	3	3 1/2	4	4 1/2	5
Length (in.)	1.128	1.240	1.562	1.872	2.062	2.260
Width (in.)	.340	.376	.511	.640	.753	.852
Hole Diameter (in.)	.082	.089	.101	.126	.124	.124
Thickness (in.)	.018	.018	.018	.018	.018	.020
Weight Per Thousand (lbs.)	1.38	1.71	2.85	4.35	6.27	8.00
Plain Brass	85160	84853	84858	84854	85140	84855
Call for Pricing						
Polished Brass	85161	84863	84868	84864	85141	84865
See Website for Pricing						
Polished Brass Lacquered	85162	84053	84058	84054	85144	84055
See Website for Pricing						
Nickeled	85165	84873	84878	84874	85147	84875
See Website for Pricing						
Gold Plate	85166	84883	84888	84884	85148	84885
Call for Pricing						

Packaging: Bulk, Polybagged

Quantity Discounts (per size): 5M-9M less 5%, 10M-24M less 10%, 25M-49M less 15%, 50M-99M less 20% 100M-Over less 25%

Discounts not available on gold.



WARNING: This product can expose you to chemicals including nickel and lead, which are known to the State of California to cause cancer and birth defects or other reproductive harm. For more information, visit www.P65Warnings.ca.gov

www.worthco.com

sales@worthco.com



Willowleaf - Serrated

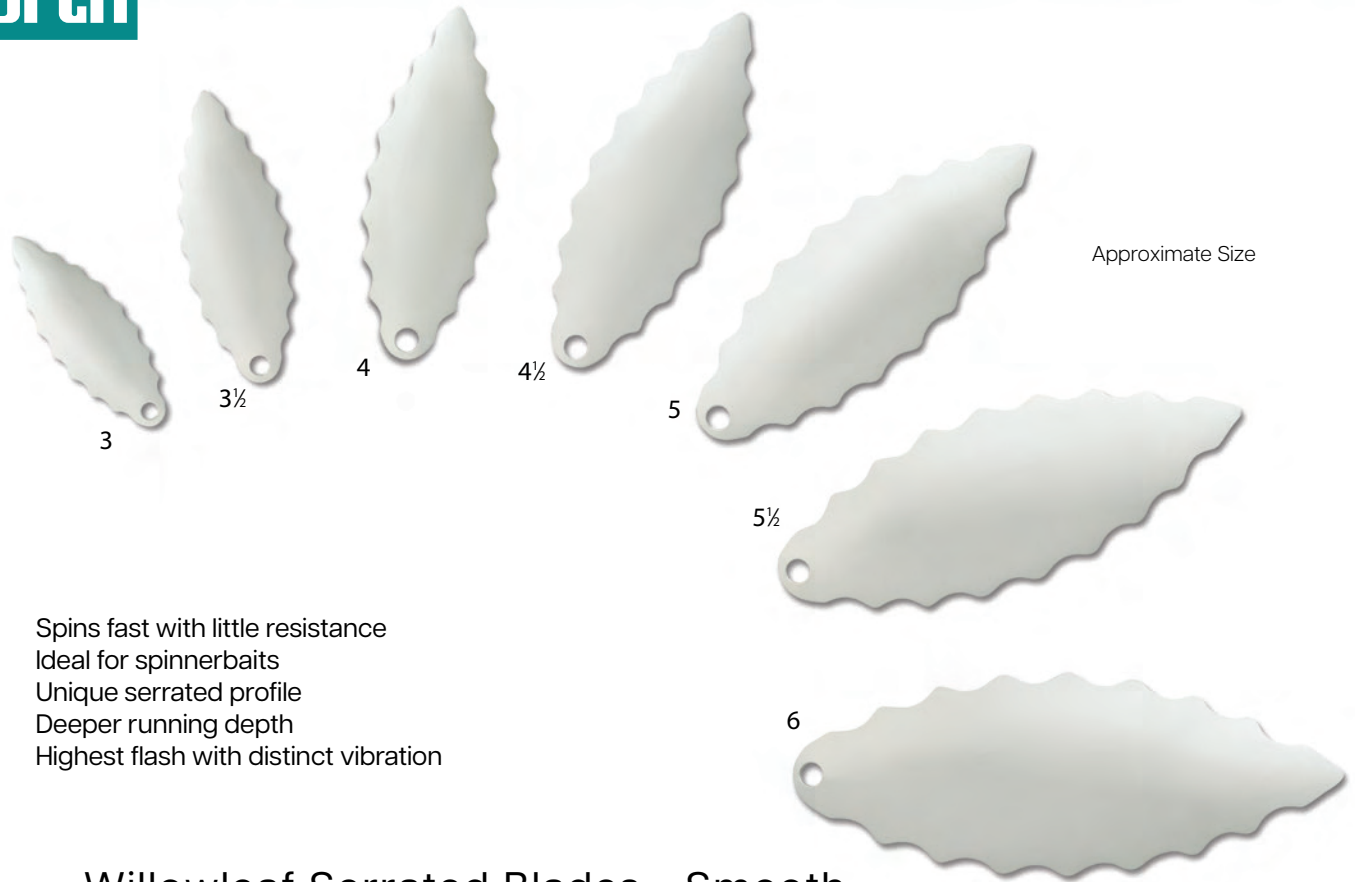

- Spins fast with little resistance
- Ideal for spinnerbaits
- Unique serrated profile
- Deeper running depth
- Highest flash with distinct vibration

Willowleaf Serrated Blades - Smooth

Size	3	3 1/2	4	4 1/2	5	5 1/2	6
Length (in.)	1.240	1.562	1.872	2.062	2.260	2.562	2.875
Width (in.)	.446	.560	.673	.747	.818	.934	1.051
Hole Diameter (in.)	.087	.100	.122	.122	.122	.122	.120
Thickness (in.)	.018	.018	.018	.018	.020	.020	.020
Weight Per Thousand (lbs.)	1.98	3.31	4.57	5.95	7.94	10.63	13.23
Plain Brass	87003	87000	87004	87001	87005	87009	87006
Call for Pricing							
Polished Brass	87013	87010	87014	87011	87015	87019	87016
See Website for Pricing							
Polished Brass Lacquered	87033	87030	87034	87031	87035	87039	87036
See Website for Pricing							
Nickel	87023	87020	87024	87021	87025	87029	87026
See Website for Pricing							

Packaging: Bulk, Polybagged

Quantity Discounts (per size): 5M-9M less 5%, 10M-24M less 10%, 25M-49M less 15%, 50M-99M less 20% 100M-Over less 25%

Discounts not available on gold.



WARNING: This product can expose you to chemicals including nickel and lead, which are known to the State of California to cause cancer and birth defects or other reproductive harm. For more information, visit www.P65Warnings.ca.gov



Willowleaf - Serrated

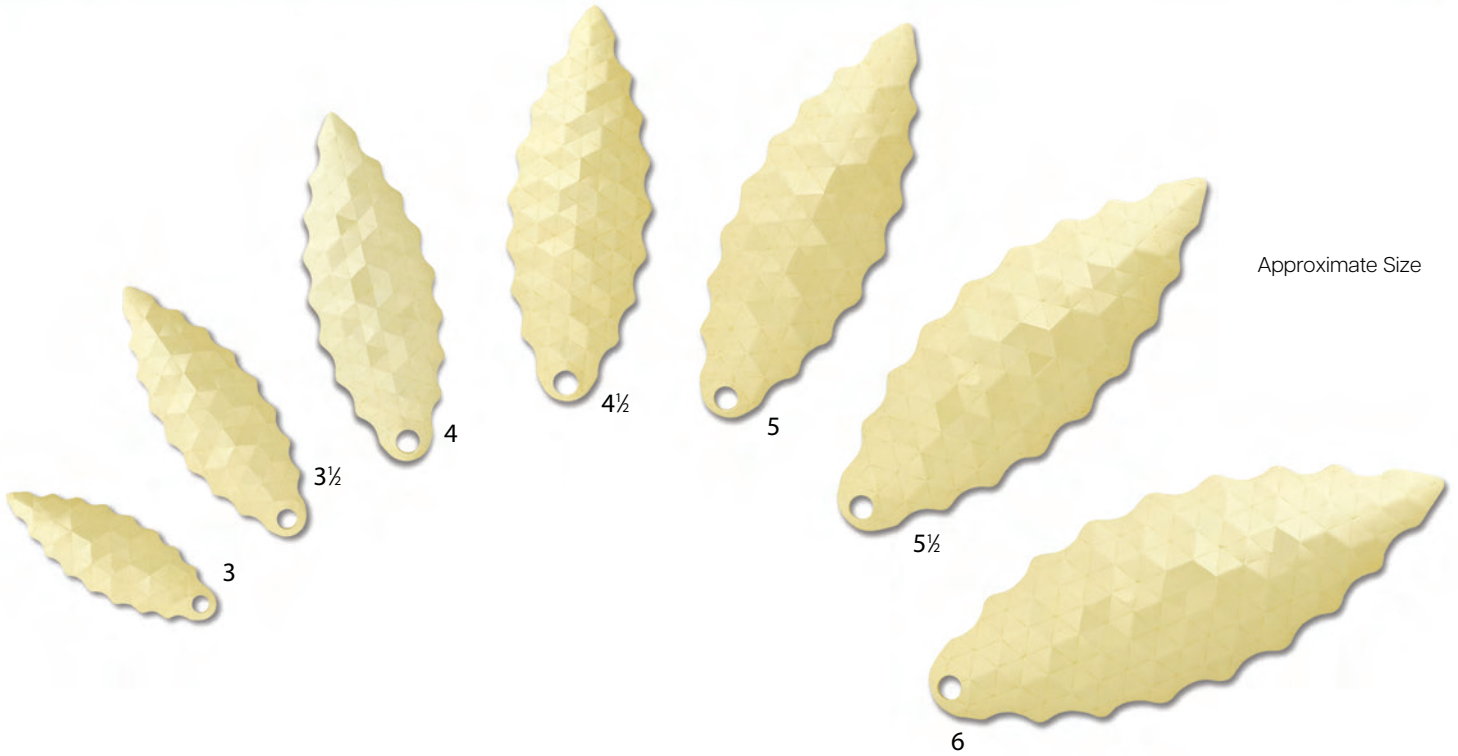

Willowleaf Serrated Blades - Hex Pattern

Size	3	3 1/2	4	4 1/2	5	5 1/2	6
Length (in.)	1.240	1.562	1.872	2.062	2.260	2.562	2.875
Width (in.)	.446	.560	.673	.747	.818	.934	1.051
Hole Diameter (in.)	.087	.100	.123	.123	.123	.122	.121
Thickness (in.)	.018	.018	.018	.018	.020	.020	.020
Weight Per Thousand (lbs.)	2.04	3.20	4.68	5.62	7.39	10.63	12.35
Plain Brass	87303	87300	87304	87301	87305	87309	87306
Call for Pricing							
Polished Brass	87313	87310	87314	87311	87315	87319	87316
See Website for Pricing							
Polished Brass Lacquered	87333	87330	87334	87331	87335	87339	87336
See Website for Pricing							
Nickeled	87323	87320	87324	87321	87325	87329	87326
See Website for Pricing							

Packaging: Bulk, Polybagged

Quantity Discounts (per size): 5M-9M less 5%, 10M-24M less 10%, 25M-49M less 15%, 50M-99M less 20% 100M-Over less 25%

Discounts not available on gold.



WARNING: This product can expose you to chemicals including nickel and lead, which are known to the State of California to cause cancer and birth defects or other reproductive harm. For more information, visit www.P65Warnings.ca.gov



Whiptail

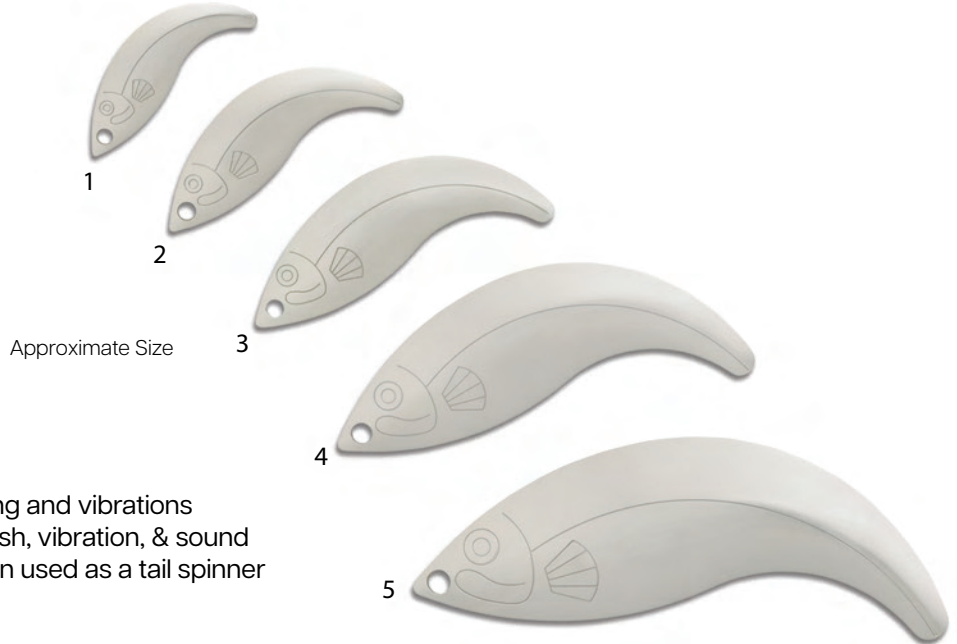

- Perfect for spinnerbaits
- Creates distinct thumping and vibrations
- Great combination of flash, vibration, & sound
- Extremely effective when used as a tail spinner

Whiptail Blades - Smooth

Size	1	2	3	4	5
Length (in.)	1.055	1.319	1.578	2.109	2.637
Width (in.)	.545	.681	.818	1.086	1.363
Hole Diameter (in.)	.079	.092	.091	.104	.117
Thickness (in.)	.018	.018	.018	.020	.020
Weight Per Thousand (lbs.)	1.54	2.54	3.75	7.16	12.12
Plain Brass	88301	88302	88303	88304	88305
Call for Pricing					
Polished Brass	88311	88312	88313	88314	88315
See Website for Pricing					
Polished Brass Lacquered	88331	88332	88333	88334	88335
See Website for Pricing					
Nickel	88321	88322	88323	88324	88325
See Website for Pricing					

Packaging: Bulk, Polybagged

Quantity Discounts (per size): 5M-9M less 5%, 10M-24M less 10%, 25M-49M less 15%, 50M-99M less 20% 100M-Over less 25%

Discounts not available on gold.



WARNING: This product can expose you to chemicals including nickel and lead, which are known to the State of California to cause cancer and birth defects or other reproductive harm. For more information, visit www.P65Warnings.ca.gov



Whiptail

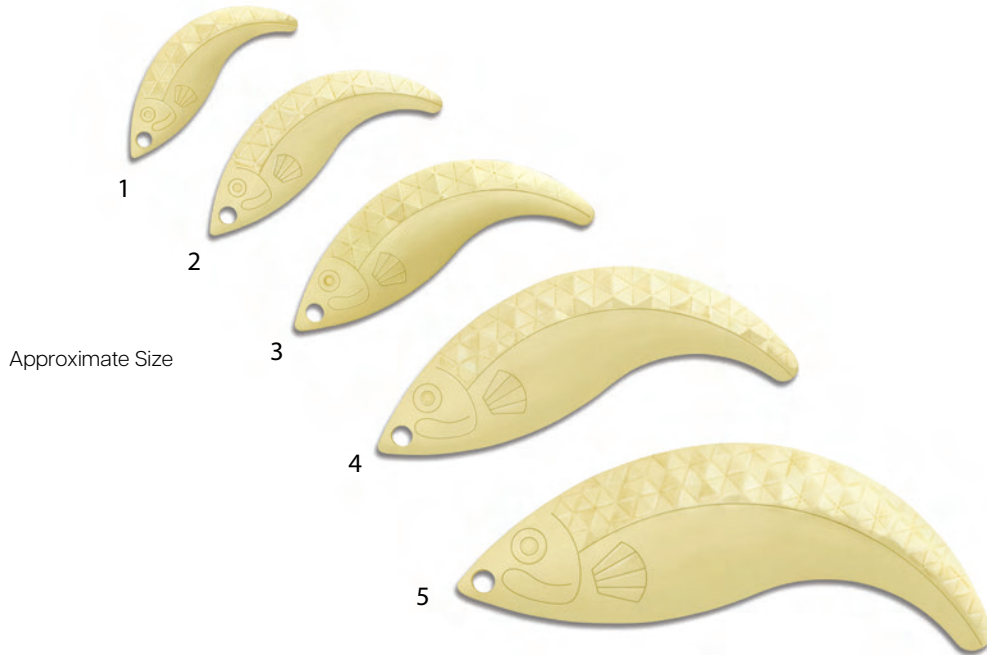

Whiptail Blades - Hex Pattern

Size	1	2	3	4	5
Length (in.)	1.055	1.319	1.578	2.109	2.637
Width (in.)	.545	.681	.818	1.086	1.363
Hole Diameter (in.)	.079	.091	.091	.104	.117
Thickness (in.)	.018	.018	.018	.020	.020
Weight Per Thousand (lbs.)	1.54	2.54	3.75	6.72	12.12
Plain Brass	88401	88402	88403	88404	88405
Call for Pricing					
Polished Brass	88411	88412	88413	88414	88415
See Website for Pricing					
Polished Brass Lacquered	88431	88432	88433	88434	88435
See Website for Pricing					
Nickeled	88421	88422	88423	88424	88425
See Website for Pricing					

Packaging: Bulk, Polybagged

Quantity Discounts (per size): 5M-9M less 5%, 10M-24M less 10%, 25M-49M less 15%, 50M-99M less 20%, 100M-Over less 25% **Discounts not available on gold.**



WARNING: This product can expose you to chemicals including nickel and lead, which are known to the State of California to cause cancer and birth defects or other reproductive harm. For more information, visit www.P65Warnings.ca.gov



Swing

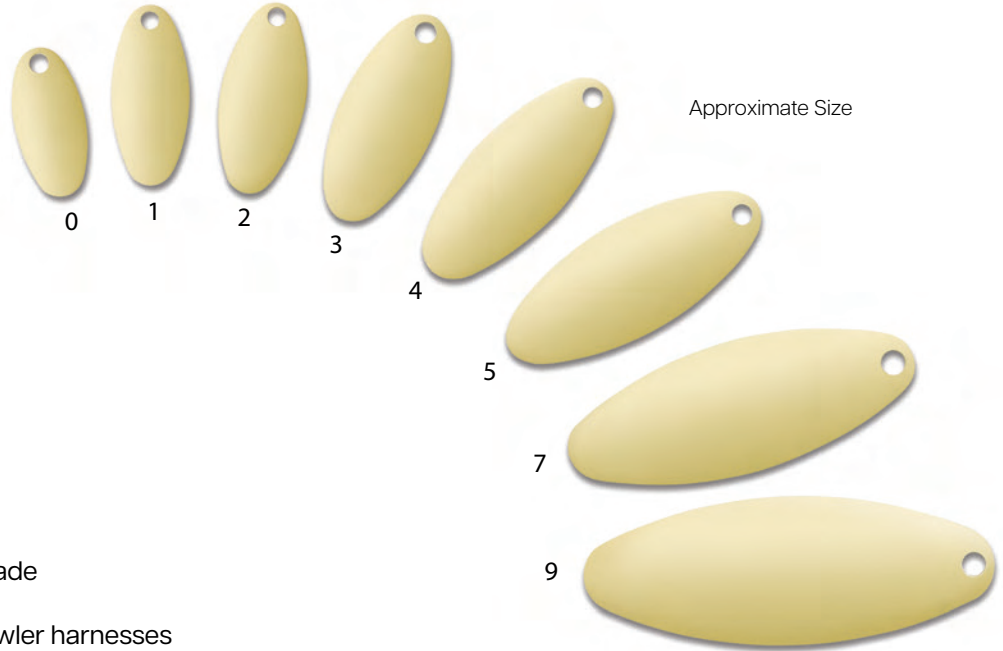

- Extremely versatile spinner blade
- Perfect for spinnerbaits
- Great for inline spinners & crawler harnesses
- Great combination of flash and spin speed

Swing Blades - Smooth

Size	0	1	2	3	4	5	7	9
Length (in.)	.792	.950	1.014	1.168	1.333	1.504	1.876	2.156
Width (in.)	.374	.406	.452	.512	.544	.596	.701	.780
Hole Diameter (in.)	.097	.092	.107	.109	.105	.103	.123	.122
Thickness (in.)	.014	.014	.014	.018	.018	.018	.020	.020
Weight Per Thousand (lbs.)	.99	1.32	1.49	2.54	3.14	3.76	6.08	7.90
Plain Brass	93600	93601	93602	93603	93604	93605	93607	93609
Call for Pricing								
Polished Brass	93610	93611	93612	93613	93614	93615	93617	93619
See Website for Pricing								
Nickeled	93620	93621	93622	93623	93624	93625	93627	93629
See Website for Pricing								
Gold Plate	93630	93631	93632	93633	93634	93635	93637	93639
Call for Pricing								

Packaging: Bulk, Polybagged

Quantity Discounts (per size): 5M-9M less 5%, 10M-24M less 10%, 25M-49M less 15%, 50M-99M less 20% 100M-Over less 25% **Discounts not available on gold.**



WARNING: This product can expose you to chemicals including nickel and lead, which are known to the State of California to cause cancer and birth defects or other reproductive harm. For more information, visit www.P65Warnings.ca.gov



Swing

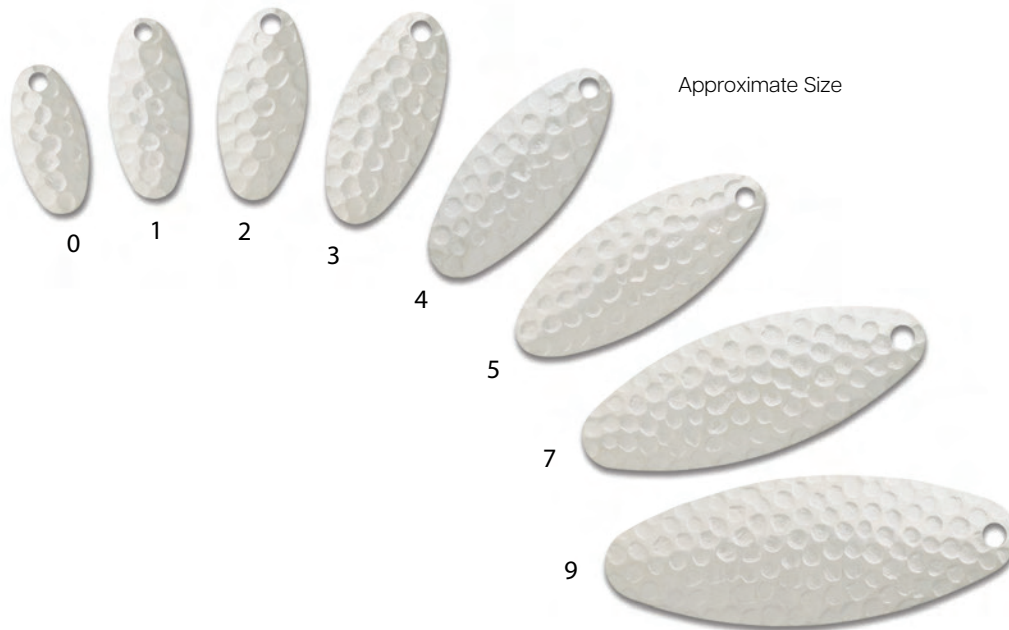

Approximate Size

Swing Blades - Hammered

Size	0	1	2	3	4	5	7	9
Length (in.)	.792	.950	1.014	1.168	1.333	1.504	1.876	2.156
Width (in.)	.374	.406	.452	.512	.544	.596	.701	.780
Hole Diameter (in.)	.098	.092	.107	.108	.105	.103	.123	.123
Thickness (in.)	.014	.014	.014	.018	.018	.018	.020	.020
Weight Per Thousand (lbs.)	.88	1.17	1.38	2.37	2.87	3.47	5.77	7.27
Plain Brass	93650	93651	93652	93653	93654	93655	93657	93659
Call for Pricing								
Polished Brass	93660	93661	93662	93663	93664	93665	93667	93669
See Website for Pricing								
Nickel	93670	93671	93672	93673	93674	93675	93677	93679
See Website for Pricing								
Gold Plate	93680	93681	93682	93683	93684	93685	93687	93689
Call for Pricing								

Packaging: Bulk, Polybagged

Quantity Discounts (per size): 5M-9M less 5%, 10M-24M less 10%, 25M-49M less 15%, 50M-99M less 20% 100M-Over less 25% **Discounts not available on gold.**



WARNING: This product can expose you to chemicals including nickel and lead, which are known to the State of California to cause cancer and birth defects or other reproductive harm. For more information, visit www.P65Warnings.ca.gov



Olympic

- Extremely versatile spinner blade
- Cupping angle creates unique flash
- Popular for targeting Salmon & Trout
- Intermediate spinning speed and running depth
- Perfect for inline spinners and finesse spinnerbaits

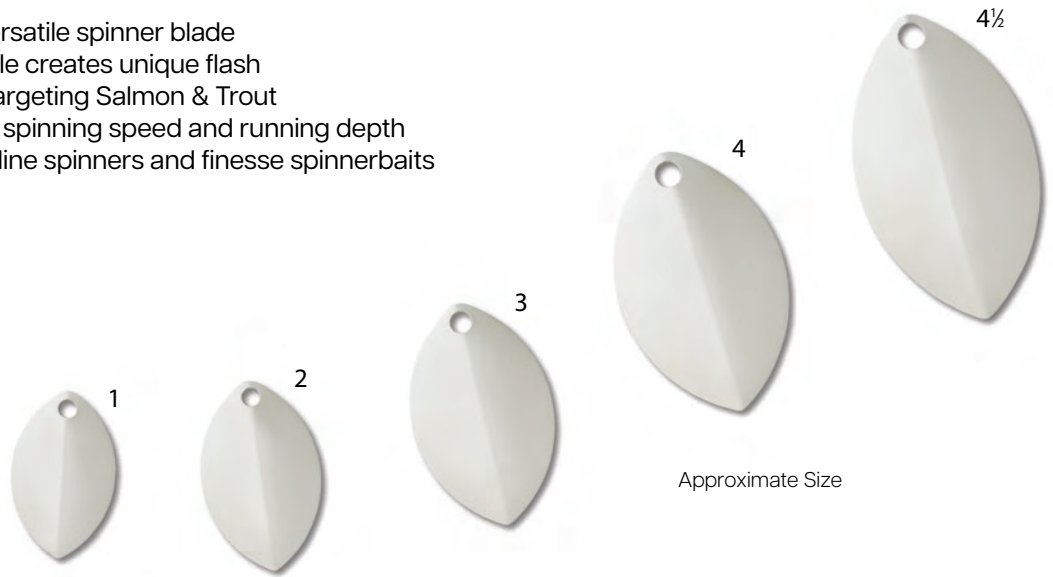

Olympic Blades - Smooth

Size	1	2	3	4	4 1/2
Length (in.)	.875	1.000	1.187	1.410	1.645
Width (in.)	.546	.624	.741	.880	.950
Hole Diameter (in.)	.091	.091	.107	.129	.132
Thickness (in.)	.018	.018	.020	.020	.020
Weight Per Thousand (lbs.)	2.00	2.88	394	5.62	7.00
Plain Brass	99111	99112	99113	99114	99119
Call for Pricing					
Polished Brass	99121	99122	99123	99124	99129
See Website for Pricing					
Polished Brass Lacquered	99131	99132	99133	99134	99139
See Website for Pricing					
Nickeled	99141	99142	99143	99144	99149
See Website for Pricing					
Gold Plate	99151	99152	99153	99154	99159
Call for Pricing					

Packaging: Bulk, Polybagged

Quantity Discounts (per size): 5M-9M less 5%, 10M-24M less 10%, 25M-49M less 15%, 50M-99M less 20%, 100M-Over less 25% **Discounts not available on gold.**



WARNING: This product can expose you to chemicals including nickel and lead, which are known to the State of California to cause cancer and birth defects or other reproductive harm. For more information, visit www.P65Warnings.ca.gov



Olympic

5



5½



6



7



Olympic Blades - Smooth

Size	5	5 ½	6	7
Length (in.)	1.881	2.052	2.220	2.466
Width (in.)	1.018	1.201	1.303	1.480
Hole Diameter (in.)	.130	.130	.150	.150
Thickness (in.)	.020	.020	.020	.020
Weight Per Thousand (lbs.)	8.52	11.02	13.15	15.56
Plain Brass	99115	99118	99116	99117
Call for Pricing				
Polished Brass	99125	99128	99126	99127
See Website for Pricing				
Polished Brass Lacquered	99135	99138	99136	99137
See Website for Pricing				
Nickeled	99145	99148	99146	99147
See Website for Pricing				
Gold Plate	99155	99158	99156	99157
Call for Pricing				

Packaging: Bulk, Polybagged

Quantity Discounts (per size): 5M-9M less 5%, 10M-24M less 10%, 25M-49M less 15%, 50M-99M less 20%, 100M-Over less 25% **Discounts not available on gold.**

Olympic Blades - Painted One Side

Note: All painted blades are brass material.

Prices stated refer to smooth blades and apply to orders of 1,000 pieces (per size and finish). Painted blades are not stock items.

Please allow 2-3 weeks for delivery.

Size	1	2	3	4	4 ½	5	5 ½	6	7
Product Number	79101	79201	79301	79401	79K01	79501	79L01	79601	79701
Call for Pricing									

Olympic Blades - Painted Two Sides

Size	1	2	3	4	4 ½	5	5 ½	6	7
Product Number	79102	79202	79302	79402	79K02	79502	79L02	79602	79702
Call for Pricing									



WARNING: This product can expose you to chemicals including nickel and lead, which are known to the State of California to cause cancer and birth defects or other reproductive harm. For more information, visit www.P65Warnings.ca.gov

www.worthco.com

sales@worthco.com



Olympic



Olympic Blades - Hammered

Size	1	2	3	4	4 ½
Length (in.)	.875	1.000	1.187	1.410	1.645
Width (in.)	.546	.624	.741	.880	.950
Hole Diameter (in.)	.092	.092	.108	.129	.133
Thickness (in.)	.018	.018	.020	.020	.020
Weight Per Thousand (lbs.)	1.77	2.88	3.75	5.13	6.90
Plain Brass	99161	99162	99163	99164	99169
Call for Pricing					
Polished Brass	99171	99172	99173	99174	99179
See Website for Pricing					
Polished Brass Lacquered	99181	99182	99183	99184	99189
See Website for Pricing					
Nickeled	99191	99192	99193	99194	99199
See Website for Pricing					
Gold Plate	99101	99102	99103	99104	99109
Call for Pricing					

Packaging: Bulk, Polybagged

Quantity Discounts (per size): 5M-9M less 5%, 10M-24M less 10%, 25M-49M less 15%, 50M-99M less 20%, 100M-Over less 25% **Discounts not available on gold.**



WARNING: This product can expose you to chemicals including nickel and lead, which are known to the State of California to cause cancer and birth defects or other reproductive harm. For more information, visit www.P65Warnings.ca.gov



Olympic



5

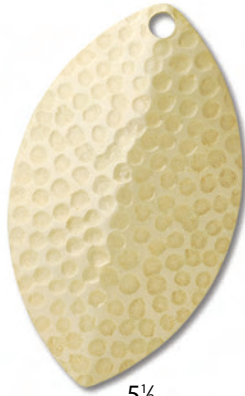

5½

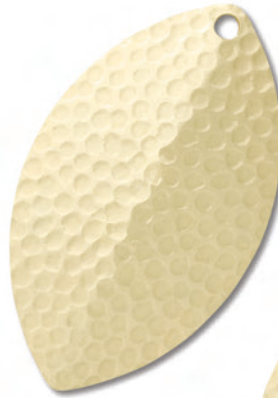

6



7

Olympic Blades - Hammered

Size	5	5 ½	6	7
Length (in.)	1.881	2.052	2.220	2.466
Width (in.)	1.018	1.201	1.303	1.480
Hole Diameter (in.)	.131	.131	.150	.150
Thickness (in.)	.020	.020	.020	.020
Weight Per Thousand (lbs.)	8.32	10.85	11.57	16.20
Plain Brass	99165	99168	99166	99167
Call for Pricing				
Polished Brass	99175	99178	99176	99177
See Website for Pricing				
Polished Brass Lacquered	99185	99188	99186	99187
See Website for Pricing				
Nickeled	99195	99198	99196	99197
See Website for Pricing				
Gold Plate	99105	99108	99106	99107
Call for Pricing				

Packaging: Bulk, Polybagged

Quantity Discounts (per size): 5M-9M less 5%, 10M-24M less 10%, 25M-49M less 15%, 50M-99M less 20%, 100M-Over less 25% **Discounts not available on gold.**



WARNING: This product can expose you to chemicals including nickel and lead, which are known to the State of California to cause cancer and birth defects or other reproductive harm. For more information, visit www.P65Warnings.ca.gov



Olympic



Approximate Size

Olympic Blades - Hex

Size	3	5
Length (in.)	1.187	1.881
Width (in.)	.741	1.018
Hole Diameter (in.)	.111	.130
Thickness (in.)	.020	.020
Weight Per Thousand (lbs.)	3.86	8.32
Plain Brass	99213	99215
Call for Pricing		
Polished Brass	99313	99315
See Website for Pricing		
Polished Brass Lacquered	99713	99715
See Website for Pricing		
Nickel	99513	99515
See Website for Pricing		
Gold Plate	99613	99615
Call for Pricing		

Packaging: Bulk, Polybagged

Quantity Discounts (per size): 5M-9M less 5%, 10M-24M less 10%,
25M-49M less 15%, 50M-99M less 20%,
100M-Over less 25%

Discounts not available on gold.



WARNING: This product can expose you to chemicals including nickel and lead, which are known to the State of California to cause cancer and birth defects or other reproductive harm. For more information, visit www.P65Warnings.ca.gov



Buzzer Blade

Approximate Size



- Outstanding vibration & sound
- Excellent free spinning action

Buzzer Blade

Size	1 7/8" x 2"
Length (in.)	1.810
Width (in.)	1.900
Hole Diameter (in.)	.045
Thickness (in.)	.018
Weight Per Thousand (lbs.)	12.35
Plain Brass	97100
See Website for Pricing	
Polished Brass	97110
See Website for Pricing	
Nickel	97120
See Website for Pricing	

Packaging: Bulk, Polybagged

Quantity Discounts (per size): 5M-9M less 5%,
10M-24M less 10%, 25M-49M less 15%, 50M-99M less 20%,
100M-Over less 25%



WARNING: This product can expose you to chemicals including nickel and lead, which are known to the State of California to cause cancer and birth defects or other reproductive harm. For more information, visit www.P65Warnings.ca.gov



Buzzer Blade - Type A

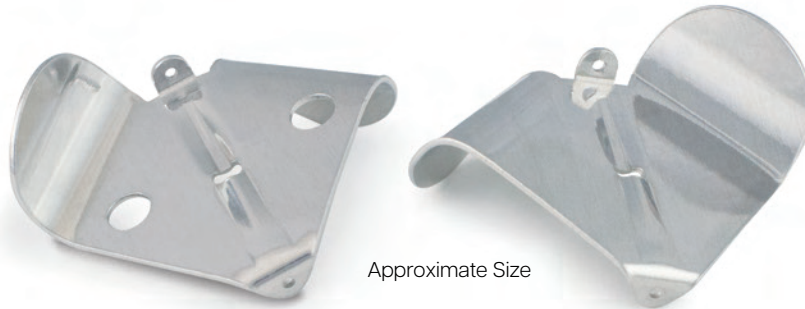

Approximate Size

- Outstanding vibration & sound
- Excellent free spinning action
- Aluminum blades ideal for top water applications
- Light weight, strong, corrosion proof aluminum blades

Buzzer Blade Type A

Size	1 7/8" x 2"
Length (in.)	1.600
Width (in.)	1.800
Hole Diameter (in.)	.054
Thickness (in.)	.032
Weight Per Thousand (lbs.)	7.540
Clockwise with Hole / Polished Aluminum	97116
Counter Clockwise with Hole / Polished Aluminum	97117
Clockwise / Polished Aluminum	97118
Counter Clockwise / Polished Aluminum	97119
See Website for Pricing	

Packaging: Bulk, Polybagged

Quantity Discounts (per size): 5M-9M less 5%, 10M-24M less 10%,
25M-49M less 15%, 50M-99M less 20%,
100M-Over less 25%



WARNING: This product can expose you to chemicals including nickel and lead, which are known to the State of California to cause cancer and birth defects or other reproductive harm. For more information, visit www.P65Warnings.ca.gov



Propeller



- Great for surface & underwater plugs
- Extremely free spinning blade at slow speeds
- Excellent for spinnerbaits & crawler harnesses

Propeller Blades

Size	0	1	2
Length (in.)	.402	.754	1.005
Width (in.)	.157	.252	.378
Hole Diameter (in.)	.041	.042	.041
Thickness (in.)	.012	.014	.018
Weight Per Thousand (lbs.)	.17	.55	1.49
Plain Brass	95810	95811	95812
Call for Pricing			
Polished Brass	95820	95821	95822
See Website for Pricing			
Nickled	95830	95831	95832
See Website for Pricing			
Gold Plate	95840	95841	95842
Call for Pricing			

Packaging: Bulk, Polybagged

Quantity Discounts (per size): 5M-9M less 5%, 10M-24M less 10%, 25M-49M less 15%, 50M-99M less 20% 100M-Over less 25%

Discounts not available on gold.



WARNING: This product can expose you to chemicals including nickel and lead, which are known to the State of California to cause cancer and birth defects or other reproductive harm. For more information, visit www.P65Warnings.ca.gov



TurboProp

Approximate Size

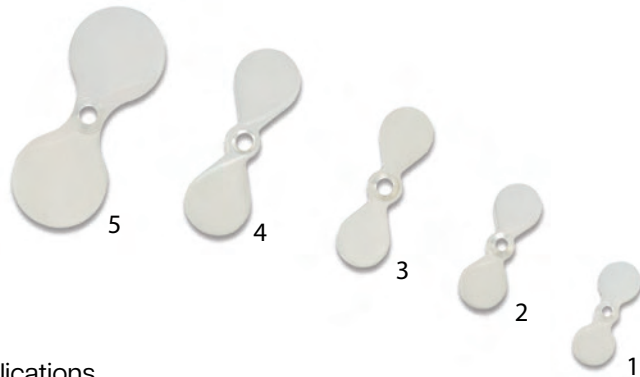

- Creates substantial turbulence
- Perfect for top water and jig applications
- Available in multiple finishes

TurboProp Blades

Size	1	2	3	4	5
Length (in.)	.576	.703	.888	1.038	1.231
Width (in.)	.224	.256	.285	.355	.508
Hole Diameter (in.)	.050	.069	.083	.084	.089
Thickness (in.)	.018	.018	.025	.025	.025
Weight Per Thousand (lbs.)	.51	.70	1.32	1.93	3.39
Plain Brass	96461	96462	96463	96464	96465
Call for Pricing					
Polished Brass	96471	96472	96473	96474	96475
See Website for Pricing					
Nickel	96481	96482	96483	96484	96485
See Website for Pricing					
Gold Plate	96491	96492	96493	96494	96495
Call for Pricing					

Packaging: Bulk, Polybagged

Quantity Discounts (per size): 5M-9M less 5%, 10M-24M less 10%, 25M-49M less 15%, 50M-99M less 20%, 100M-Over less 25% **Discounts not available on gold.**

TurboProp Blades - Painted Two Sides

Size	1	2	3	4	5
Product Number	7U102	7U202	7U302	7U402	7U502
Call for Pricing					

Note: All painted blades are brass material. Prices stated refer to smooth blades and apply to orders of 1,000 pieces (per size and finish). Painted blades are not stock items. Please allow 2-3 weeks for delivery.



WARNING: This product can expose you to chemicals including nickel and lead, which are known to the State of California to cause cancer and birth defects or other reproductive harm. For more information, visit www.P65Warnings.ca.gov



Easy Spin Clevis

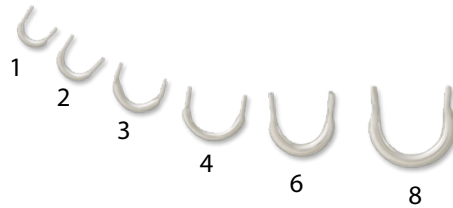

Approximate Size



Enlarged View

- Extremely free spining
- Premium brass material
- Most popular clevis style
- Perfect for spinner blades

Please note: The indicated hole diameters are punch sizes only and may not accommodate wire shafts near those maximum sizes. If in doubt, request samples.

Easy Spin Clevis

Size	1	2	3	4	6	8
Maximum Wire Diameter	.036 in / 0.91 mm	.036 in / 0.91 mm	.045 in / 1.14 mm	.048 in / 1.22 mm	.065 in / 1.65 mm	.072 in / 1.83 mm
Weight Per Thousand (lbs.)	0.11	0.14	0.23	0.27	0.66	1.15
Polished Brass	96511	96512	96513	96514	96516	96518
See Website for Pricing						
Stainless Steel		96572				96578
See Website for Pricing						
Nickeled	96521	96522	96523	96524	96526	96528
See Website for Pricing						

Packaging: Bulk, Polybagged

Quantity Discounts (per size): 5M-9M less 5%, 10M-24M less 10%, 25M-49M less 15%, 50M-99M less 20% 100M-Over less 25%



WARNING: This product can expose you to chemicals including nickel and lead, which are known to the State of California to cause cancer and birth defects or other reproductive harm. For more information, visit www.P65Warnings.ca.gov



Strip Clevis



Approximate Size

- Heavyweight clevis with classic design
- Formed from the highest quality solid brass strip
- Oversized .080" holes for larger wire diameters
- Perfect for spinnerbaits or large musky & pike lures

Strip Clevis

Maximum Wire Diameter	.078 in / 1.98 mm
Weight Per Thousand (lbs.)	0.55
Polished Brass	93550
See Website for Pricing	
Nickel	93560
See Website for Pricing	

Packaging: Bulk, Polybagged

Quantity Discounts (per size): 5M-9M less 5%, 10M-24M less 10%,
25M-49M less 15%, 50M-99M less 20%,
100M-Over less 25%



WARNING: This product can expose you to chemicals including nickel and lead, which are known to the State of California to cause cancer and birth defects or other reproductive harm. For more information, visit www.P65Warnings.ca.gov



Folded Clevis

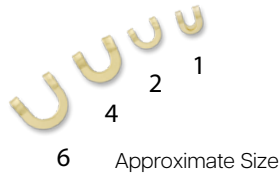

- Free action to the spinner blade
- Finely detailed clevises at a lower cost
- Stamped and formed in one operation from solid brass

Folded Clevises

Size	1	2	4	6
Maximum Wire Diameter	.038 in / .97 mm	.038 in / .97 mm	.052 in / 1.32 mm	.060 in / 1.52 mm
Weight Per Thousand (lbs.)	0.07	0.06	0.13	0.17
Polished Brass	96711	96712	96714	96716
See Website for Pricing				
Nickeled	96721	96722	96724	96726
See Website for Pricing				

Packaging: Bulk, Polybagged

Quantity Discounts (per size): 5M-9M less 5%, 10M-24M less 10%, 25M-49M less 15%, 50M-99M less 20%, 100M-Over less 25%



WARNING: This product can expose you to chemicals including nickel and lead, which are known to the State of California to cause cancer and birth defects or other reproductive harm. For more information, visit www.P65Warnings.ca.gov



Clip N Spin Clevis

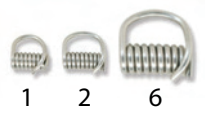

Approximate Size



Enlarged View

- Interchangeable blade clevis
- Spins true
- Easy to use
- Keeps blades secure
- Extremely durable stainless steel

Clip N Spin Clevis

Size	1	2	6
Width "Side to Side"	.180 in / 4.57 mm	.240 in / 6.10 mm	.410 in / 10.41mm
Length "Top to Bottom"	.185 in / 4.70 mm	.242 in / 6.15 mm	.432 in / 10.97mm
# of Coils "Top to Bottom"	6	8	9
Maximum Hole Diameter	.040	.040	.054
Weight Per Thousand (lbs.)	0.328	0.438	1.814
Stainless Steel	96791	96792	96796
See Website for Pricing			

Packaging: Bulk, Polybagged

Quantity Discounts (per size): 5M-9M less 5%, 10M-24M less 10%, 25M-49M less 15%, 50M-99M less 20% 100M-Over less 25%



WARNING: This product can expose you to chemicals including nickel and lead, which are known to the State of California to cause cancer and birth defects or other reproductive harm. For more information, visit www.P65Warnings.ca.gov



Double Clevis



Approximate Size

6



Enlarged View

- For use in Musky and Pike baits
- Baits can be retrieved slower
- Blades engage virtually every time on casts
- Easier to assemble verses two clevises

Double Clevis

Size	6
Maximum Wire Diameter	.055 in / mm
Weight Per Thousand (lbs.)	1.38
Polished Brass	96546
See Website for Pricing	
Nickled	96556
See Website for Pricing	

Packaging: Bulk, Polybagged

Quantity Discounts (per size): 5M-9M less 5%,
10M-24M less 10%



WARNING: This product can expose you to chemicals including nickel and lead, which are known to the State of California to cause cancer and birth defects or other reproductive harm. For more information, visit www.P65Warnings.ca.gov



Disc Washers



Approximate Size

- Used at the head and rear of plugs and hardbaits
- Used with screw eyes for appearance
- Great as a bearing surface between propellers and lure bodies
- Made from solid nickel-plated brass
- .045 x 7/32" O.D. 7/64" I.D.

Disc Washer

Size	6
Maximum Wire Diameter	.055 in / mm
Weight Per Thousand (lbs.)	0.40
Nickel	98902
See Website for Pricing	

Packaging: Bulk, Polybagged

Quantity Discounts (per size):

5M-9M less 5%, 10M-24M less 10%, 25M-49M less 15%,
50M-99M less 20%, 100M-Over less 25%



WARNING: This product can expose you to chemicals including nickel and lead, which are known to the State of California to cause cancer and birth defects or other reproductive harm. For more information, visit www.P65Warnings.ca.gov



Swivel - Ball Bearing

Size 2

Approximate Size



Large Eye Swivels

After years of design, engineering development and the production of millions and millions of swivels the Worth Ball Bearing Swivel continues to set the standard in the tackle industry among OEM fishing tackle manufacturers. Our swivels feature highly polished, precision stainless steel ball bearings, in conjunction with tapered bearing surfaces that combine for a smooth, almost effortless spinning action.

The sleek outer case and ribbed inner jacket design will give our Worth Ball Bearing Swivel the strength and durability you need for all spinnerbait applications. In addition, the special stem design reduces friction and lock-up. We suggest attaching our #2.5 fine nickel split ring. This ring was especially designed to accommodate this ball bearing swivel for perfect balance and performance.

Ball Bearing Swivels

Size 2	Swivel Only	Large Eye Swivel Only
Stationary Housing Hole Dia.	.040	.070
Weight Per Thousand (lbs.)	0.88	1.02
Nickel	94922	98422
See Website for Pricing		

Packaging: Bulk, 1000 each

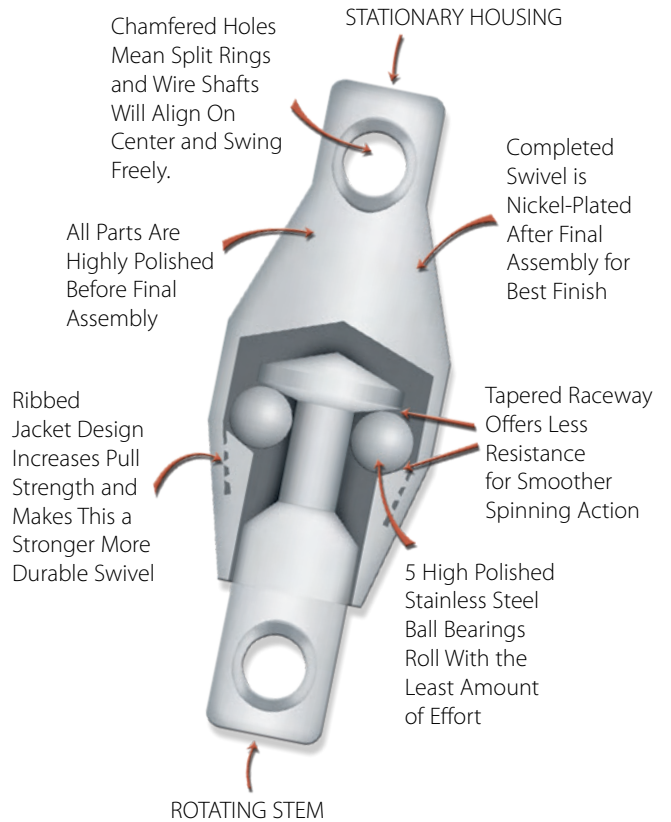

Ball Bearing Swivels With Rings

Size 2	Swivel With Front Ring Only	Swivel With Two Split Rings	2 ½ Fine Split Rings	Large Eye With Front Ring
Stationary Housing Hole Dia.	.040	.040		.070
Weight Per Thousand (lbs.)	1.03	1.18	0.15	1.16
Nickel	94942	94952	92513	98442
See Website for Pricing				

Packaging: Bulk, Polybagged

Quantity Discounts (per size): 5M-9M less 5%, 10M-24M less 17%, 25M-49M less 25%, 50M-99M less 29% 100M-Over less 25%



WARNING: This product can expose you to chemicals including nickel and lead, which are known to the State of California to cause cancer and birth defects or other reproductive harm. For more information, visit www.P65Warnings.ca.gov



Swivels - Barrel

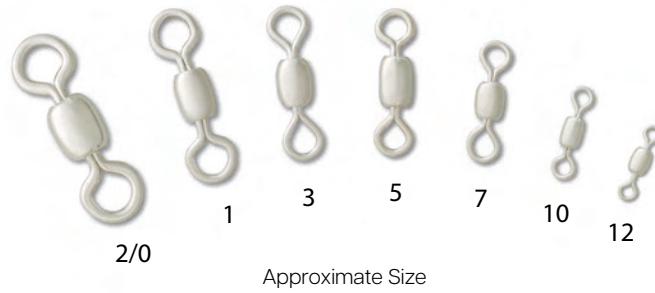

- High quality American made swivel
- Smooth and precise swivel action
- Prevents kinking and twisting of the line

Barrel Swivels

Size	12	10	7	5	3	1	2/0
Weight Per Thousand (lbs.)	0.28	0.43	0.93	1.81	1.93	2.50	5.12
Polished Brass	97912	97910	97907	97905	97903	97901	97920
See Website for Pricing							
Nickel	97812	97810	97807	97805	97803	97801	97820
See Website for Pricing							

Packaging: Bulk, Polybagged

Quantity Discounts (per size): 5M-9M less 5%, 10M-24M less 10%, 25M-49M less 15%, 50M-99M less 20% 100M-Over less 25%



WARNING: This product can expose you to chemicals including nickel and lead, which are known to the State of California to cause cancer and birth defects or other reproductive harm. For more information, visit www.P65Warnings.ca.gov



Red Flipper



Approximate Size

- Adds a bright red flash to lures
- Attaches to the split ring
- Irresistible look fish can't resist

Red Flipper

Size	0
Length (in.)	.546
Width (in.)	.320
Hole Diameter (in.)	.077
Thickness (in.)	.020
Weight Per Thousand (lbs.)	0.11
Matte Red	98410
See Website for Pricing	

Packaging: Bulk, Polybagged







WARNING: This product can expose you to chemicals including nickel and lead, which are known to the State of California to cause cancer and birth defects or other reproductive harm. For more information, visit www.P65Warnings.ca.gov









Lure Bodies

Our precision-turned brass lure bodies are manufactured using premium brass and are available in seventeen sizes and shapes.

Lure Bodies

Lure Bodies	 A	 B	 C	 D	 E
Approx. Hole Diameter	.055 in / 1.19 mm	.050 in / 1.19 mm	.055 in / 1.19 mm	.058 in / 1.37 mm	.054 in / 1.27 mm
Weight	.065 oz / 1.85 gr	.078 oz / 2.21 gr	.126 oz / 3.56 gr	.227 oz / 6.44 gr	.056 oz / 1.59 gr
Weight Per Thousand	4.11 lb / 1.85 kg	5.32 lb / 2.21 kg	7.78 lb / 3.56 kg	14.20 lb / 6.44 kg	3.56 lb / 1.59 kg
Polished Brass	97500*	97510	97520	97525	97530*
See Website for Pricing					
Nickel	97600*	97610	97620	97625	97630*
See Website for Pricing					

Bodies marked * are recessed, all others are flush

Lure Bodies	 F	 G	 H	 I	 J	 K
Approx. Hole Diameter	.060 in / 1.44 mm	.051 in / 1.19 mm	.051 in / 1.19 mm	.061 in / 1.47 mm	.048 in / 1.19 mm	.054 in / 1.19 mm
Weight	.092 oz / 2.62 gr	.057 oz / 1.62 gr	.128 oz / 3.63 gr	.236 oz / 6.68 gr	.080 oz / 2.26 gr	.103 oz / 2.91 gr
Weight Per Thousand	5.36 lb / 2.62 kg	3.85 lb / 1.62 kg	8.11 lb / 3.63 kg	14.10 lb / 6.68 kg	5.09 lb / 2.26 kg	6.08 lb / 2.91 kg
Polished Brass	97540*	97545*	97546*	97550	97560	97562
See Website for Pricing						
Nickel	97640*	97645*	97646*	97650	97660	97662
See Website for Pricing						

Bodies marked * are recessed, all others are flush

Packaging: Bulk, Polybagged

Quantity Discounts (per size): 5M-9M less 5%, 10M-24M less 10%









WARNING: This product can expose you to chemicals including nickel and lead, which are known to the State of California to cause cancer and birth defects or other reproductive harm. For more information, visit www.P65Warnings.ca.gov



Lure Bodies

Lure Bodies

Lure Bodies	 L	 M	 N	 O	 P	 Q
Approx. Hole Diameter	.048 in / 1.19 mm	.048 in / 1.19 mm	.048 in / 1.19 mm	.051 in / 1.19 mm	.054 in / 1.19 mm	.052 in / 1.19mm
Weight	.067 oz / 1.89 gr	.099 oz / 2.80 gr	.107 oz / 3.04 gr	--	--	--
Weight Per Thousand	4.02 lb / 1.89 kg	5.94 lb / 2.80 kg	7.04 lb / 3.04 kg	0.30 lb / 0.15 kg	0.69 lb / 0.35 kg	1.16 lb / 0.40 kg
Polished Brass	97563	97565	97567	97570	97571	97572
See Website for Pricing						
Nickeled	97663	97665	97667	97670	97671	97672
See Website for Pricing						

Packaging: Bulk, Polybagged

Quantity Discounts (per size): 5M-9M less 5%, 10M-24M less 10%



Approximate Size

Heavy Weight Lure Bodies

Size	3/16 oz	1/4 oz	3/8 oz	1/2 oz
Length	1.05 in / 26.67 mm	1.145 in / 29.08 mm	1.318 in / 33.48 mm	1.310 in / 33.29 mm
Approx. Hole Diameter	.068 in / 1.73 mm	.070 in / 1.78 mm	.068 in / 1.73 mm	.070 in / 1.78 mm
Weight	.188 oz. / 5.33 gr	.250 oz / 7.09 gr	.375 oz / 10.63 gr	.500 oz / 14.18 gr
Weight Per Thousand	11.50 lb / 9.89 kg	16 lb / 7.26 kg	21.80 lb / 10.14 kg	32 lbs / 14.51 kg
Polished Brass	97573	97569	97555	97553
See Website for Pricing				
Nickeled	97673	97669	97655	97653
See Website for Pricing				

Packaging: Bulk, Polybagged

Quantity Discounts (per size): 5M-9M less 5%, 10M-24M less 10%



WARNING: This product can expose you to chemicals including nickel and lead, which are known to the State of California to cause cancer and birth defects or other reproductive harm. For more information, visit www.P65Warnings.ca.gov



Solid Brass Beads



Approximate Size

- Highly precise solid brass beads for weigh and spacing
- Ideal for spacers, decoration, and fine tuning lures
- Multiple sizes and weight options
- Great as a bearing surface

Solid Brass Beads

Size	3/32 in / 2.38 mm	1/8 in / 3.17 mm	5/32 in / 3.97 mm	3/16 in / 4.76 mm	7/32 in / 5.55 mm
Approx. Hole Diameter	.039 in / .99 mm	.055 in / 1.32 mm	.055 in / 1.32 mm	.055 in / 1.32 mm	.064 in / 1.63 mm
Weight Per Thousand	.08 lb / .035 kg	.20 lb / .104 kg	.45 lb / .204 kg	.85 lb / .422 kg	1.42 lb / .671 kg
Polished Brass	97310	97311	97312	97313	97314
See Website for Pricing					
Nickel-Plated	97320	97321	97322	97323	97324
See Website for Pricing					

Size	1/4 in / 6.35 mm	9/32 in / 7.14 mm	5/16 in / 7.94 mm	11/32 in / 8.73 mm	3/8 in / 9.52 mm
Approx. Hole Diameter	.064 in / 1.63 mm	.063 in / 1.61 mm	.072 in / 1.83 mm	.072 in / 1.83 mm	.072 in / 1.83 mm
See Website for Pricing	2.19 lb / 1.02 kg	3.09 lb / 1.45 kg	4.35 lb / 2.00 kg	5.89 lb / 2.72 kg	7.75 lb / 3.76 kg
Polished Brass	97315	97316	97317	97318	97319
See Website for Pricing					
Nickel-Plated	97325	97326	97327	97328	97329
See Website for Pricing					

Packaging: Bulk, Polybagged

Quantity Discounts (per size): 5M-9M less 5%, 10M-24M less 10%



WARNING: This product can expose you to chemicals including nickel and lead, which are known to the State of California to cause cancer and birth defects or other reproductive harm. For more information, visit www.P65Warnings.ca.gov



Hollow Metal Beads



- Ideal for spacers, decoration, and fine tuning lures
- Economically priced hollow metal beads
- Great as a bearing surface

Hollow Metal Beads

Size	5/64 in / 1.99 mm	3/32 in / 2.38 mm	1/8 in / 3.17 mm	5/32 in / 3.97 mm
Approx. Hole Dia. +/- .010 in.	.047 in / 1.20 mm	.047 in / 1.20 mm	.047 in / 1.20 mm	.063 in / 1.61 mm
Weight Per Thousand	.05 lb / .023 kg	.06 lb / .027 kg	.14 lb / .059 kg	.24 lb / .113 kg
Gold Finish	97340	97341	97342	97343
See Website for Pricing				
Nickel Finish	97330	97331	97332	97333
See Website for Pricing				

Size	3/16 in / 4.76 mm	7/32 in / 5.55 mm	1/4 in / 6.35 mm	5/16 in / 7.94 mm
Approx. Hole Dia. +/- .010 in.	.063 in / 1.61 mm	.063 in / 1.61 mm	.063 in / 1.61 mm	.078 in / 1.99 mm
Weight Per Thousand	.44 lb / .200 kg	.68 lb / .304 kg	.90 lb / .386 kg	1.90 lb / .821 kg
Gold Finish	97344	97345	97346	97347
See Website for Pricing				
Nickel Finish	97334	97335	97336	97337
See Website for Pricing				

Packaging: Bulk, Polybagged

Quantity Discounts (per size): 5M-9M less 5%, 10M-24M less 10%, 25M-49M less 15%, 50M-99M less 20% 100M-Over less 25%



WARNING: This product can expose you to chemicals including nickel and lead, which are known to the State of California to cause cancer and birth defects or other reproductive harm. For more information, visit www.P65Warnings.ca.gov



Round Plastic Beads

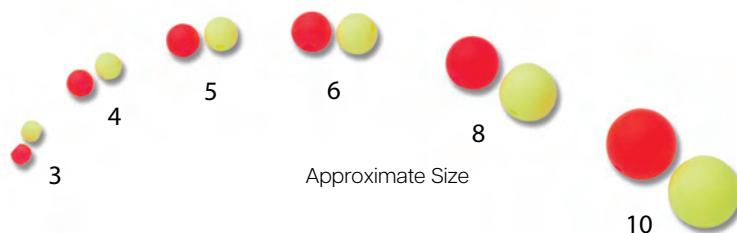

- Ideal for trout and salmon lures
- Multiple sizes and colors
- Highest visibility for attracting fish
- Great as a bearing surface
- Perfect for adding color and spacing to spinning lures

Round Plastic Beads

Size (mm)	3	4	5
Approx. Hole Diameter (in)	.044	.044	.048
Weight Per Thousand (lbs)	.03	.08	.16
Salmon Red	97012	97014	97015
See Website for Pricing			
Chartreuse	97052	97054	97055
See Website for Pricing			

Size (mm)	6	8	10
Approx. Hole Diameter (in)	.048	.048	.048
Weight Per Thousand (lbs)	.29	.67	1.42
Salmon Red	97016	97018	97019
See Website for Pricing			
Chartreuse	97056	97058	97059
See Website for Pricing			

Packaging: Bulk, Polybagged

Quantity Discounts (per size): 5M-9M less 5%, 10M-24M less 10%, 25M-49M less 15%, 50M-99M less 20%, 100M-Over less 25%



WARNING: This product can expose you to chemicals including nickel and lead, which are known to the State of California to cause cancer and birth defects or other reproductive harm. For more information, visit www.P65Warnings.ca.gov



Tear Drop Plastic Beads



Approximate Size

- Ideal for trout and salmon lures
- Highest visibility for attracting fish
- Great as a bearing surface
- Perfect for adding color and spacing to spinning lures

Tear Drop Plastic Bead

Size (mm)	12 x 18
Approx. Hole Diameter (in)	.048
Weight Per Thousand (lbs)	3.24
Salmon Red	97039
See Website for Pricing	

Packaging: Bulk, Polybagged

Quantity Discounts (per size):

5M-9M less 5%, 10M-24M less 10%, 25M-49M less 15%,
50M-99M less 20% 100M-Over less 25%



WARNING: This product can expose you to chemicals including nickel and lead, which are known to the State of California to cause cancer and birth defects or other reproductive harm. For more information, visit www.P65Warnings.ca.gov



Oval Plastic Beads

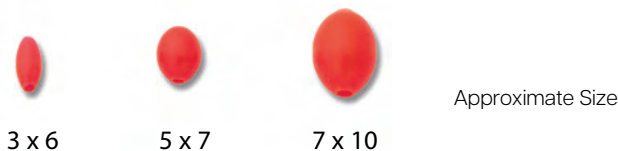

- Ideal for trout and salmon lures
- Multiple sizes
- Highest visibility for attracting fish
- Great as a bearing surface
- Perfect for adding color and spacing to spinning lures

Oval Plastic Beads

Size (mm)	3 x 6	5 x 7	7 x 10
Approx. Hole Diameter (in)	.044	.048	.048
Weight Per Thousand (lbs)	.07	.22	.65
Salmon Red	97023	97025	97027
See Website for Pricing			

Packaging: Bulk, Polybagged

Quantity Discounts (per size): 5M-9M less 5%, 10M-24M less 10%, 25M-49M less 15%, 50M-99M less 20%, 100M-Over less 25%



WARNING: This product can expose you to chemicals including nickel and lead, which are known to the State of California to cause cancer and birth defects or other reproductive harm. For more information, visit www.P65Warnings.ca.gov



Figure 8 Hook Hangers

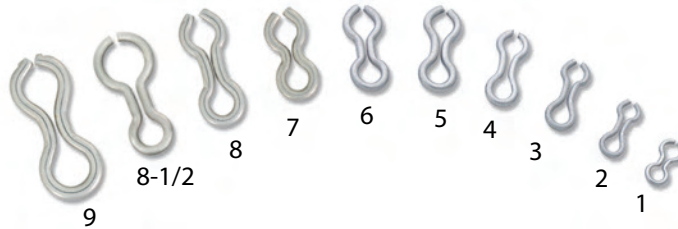

Approximate Size

- Made from the finest quality stainless steel
- Corrosion proof
- Ten stock sizes available
- Fits most styles of crankbait manufacturing and sinker molds
- Custom sizes available upon request

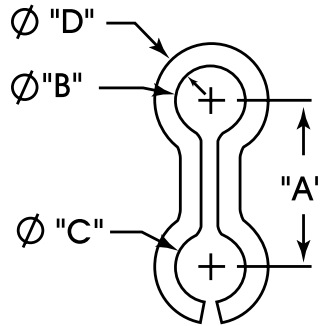

Figure 8 Hook Hangers

Size	1	2	3	4	5	6	7	8	8 1/2	9
"A" Dimension (in)	.138	.225	.240	.250	.280	.250	.250	.360	.398	.460
"B" Dimension (in)	.063	.077	.097	.082	.082	.096	.118	.116	.125	.191
"C" Dimension (in)	.068	.074	.113	.078	.086	.084	.117	.120	.207	.188
"D" Dimension (in)	.025	.032	.041	.036	.036	.041	.057	.062	.057	.072
Weight Per Thousand (lb)	.08	.19	.38	.27	.29	.37	.81	1.17	1.18	2.13
Catalog Number	98811	98812	98818	98813	98819	98814	98817	98815	98820	98816
See Website for Pricing										

Packaging: Bulk, Polybagged

Quantity Discounts (per size): 5M-9M less 5%, 10M-24M less 10%, 25M-49M less 15%, 50M-99M less 20%, 100M-Over less 25%



WARNING: This product can expose you to chemicals including nickel and lead, which are known to the State of California to cause cancer and birth defects or other reproductive harm. For more information, visit www.P65Warnings.ca.gov



Coil Spring Fasteners



Approximate Size

- Often used as spacers
- Precision-made from the finest .012" stainless wire
- Tightly coiled to ensure positive locking
- Available in three inside diameters
- Special diameters and lengths are available upon request

Approximate coil ID .045 to fit wire shafts .020" to .022" "single wire"

Approximate coil ID .051 to fit wire shafts .024" to .026" "single wire"

Approximate coil ID .064 to fit wire shafts .028" to .032" "single wire"

Coil Spring Fasteners

Length	1/4 "	3/8"	1/2"	5/8"	3/4"	7/8"	1"
.045 Weight Per Thou.	.11 lb	.17 lb	.23 lb	.29 lb	.38 lb	.40 lb	.51 lb
Approx. ID .045 S.S.	98751	98752	98753	98754	98755	98756	98757
See Website for Pricing							
.051 Weight Per Thou.	.12 lb	.19 lb	.25 lb	.32 lb	.38 lb	.45 lb	.51 lb
Approx. ID .051 S.S.	98761	98762	98763	98764	98765	98766	98767
See Website for Pricing							
.064 Weight Per Thou.	.15 lb	.23 lb	.30 lb	.38 lb	.46 lb	.55 lb	.62 lb
Approx. ID .064 S.S.	98771	98772	98773	98774	98775	98776	98777
See Website for Pricing							

Packaging: Bulk, Polybagged

Quantity Discounts (per size): 5M-9M less 5%, 10M-24M less 10%, 25M-49M less 15%, 50M-99M less 20%, 100M-Over less 25%



WARNING: This product can expose you to chemicals including nickel and lead, which are known to the State of California to cause cancer and birth defects or other reproductive harm. For more information, visit www.P65Warnings.ca.gov



Wire Forms - Straight Shaft



- Top-quality stainless steel for the finest in corrosion and rust protection, strength, and durability

Note: Special lengths available in 5,000 or greater quantities upon quotation.
Catalog numbers denoted by * are carried in stock.

Straight Length Stainless Steel Wire

Length	3"	4"	5"	6"	7"	8"	9"	10"	11"	12"
.022 in / .56 mm	99823	99824	99825	99826	99827	99828	--	--	--	--
Weight Per Thousand (lbs)	.32	.43	.54	.65	.75	.86				
See Website for Pricing										
.024 in / .61 mm	99833*	99834	99835	99836	99837	99838	--	--	--	--
Weight Per Thousand (lbs)	.38	.51	.64	.76	.89	1.02				
See Website for Pricing										
.028 in / .71 mm	99843	99844	99845	99846	99847	99848	--	--	--	--
Weight Per Thousand (lbs)	.52	.69	.87	1.04	1.22	1.39				
See Website for Pricing										
.030 in / .76 mm	99853	99854*	99855*	99856*	99857*	99858*	99859	99850	99851	99852
Weight Per Thousand (lbs)	.60	.80	1.00	1.20	1.40	1.60	1.80	2.00	2.20	2.40
See Website for Pricing										
.036 in / .92 mm	99883	99884	99885	99886	99887	99888	99889	99880	99881	99882
Weight Per Thousand (lbs)	.883	1.18	1.28	1.54	1.79	2.05	2.31	2.57	3.17	3.08
See Website for Pricing										
.040 in / 1.01 mm	99863	99864	99865	99866	99867	99868	99869	99860	99861	99862
Weight Per Thousand (lbs)	1.06	1.42	1.77	2.13	2.49	2.84	3.20	3.55	3.91	4.26
See Website for Pricing										
.045 in / 1.14 mm	--	99874	--	99876	99877	99878	--	--	--	--
Weight Per Thousand (lbs)		1.80		2.70	3.15	3.68				
See Website for Pricing										
.051 in / 1.30 mm	--	--	--	99896	99897	99898	99899	99890	99891	99892
Weight Per Thousand (lbs)				3.47	4.05	4.63	5.21	5.79	6.37	6.95
See Website for Pricing										

Packaging: Bulk, 500 per bundle

Quantity Discounts (per type & length): 5M-9M less 5%, 10M-24M less 10%



WARNING: This product can expose you to chemicals including nickel and lead, which are known to the State of California to cause cancer and birth defects or other reproductive harm. For more information, visit www.P65Warnings.ca.gov



Wire Forms - Type A

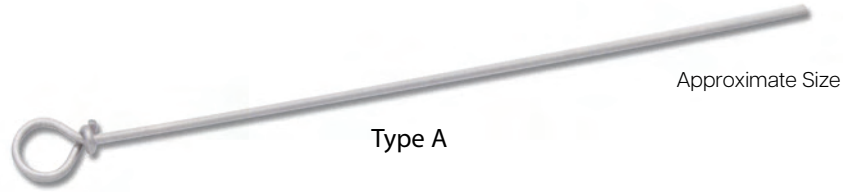

- Top-quality stainless steel for the finest in corrosion and rust protection, strength, and durability

Note: Special lengths available in 5,000 or greater quantities upon quotation.
Catalog numbers denoted by * are carried in stock.

Type A Stainless Steel Wire

Length	3"	4"	5"	6"	7"	8"
.020 in / .51 mm	--	--	--	--	--	99218
Weight Per Thousand (lbs)						.75
See Website for Pricing						
.022 in / .56 mm	99223	99224	99225	99226	99227	99228
Weight Per Thousand (lbs)	.36	.47	.62	.64	.75	.86
See Website for Pricing						
.024 in / .61 mm	99233*	99234	99235	99236	99237	99238
Weight Per Thousand (lbs)	.46	.57	.75	.85	.96	1.13
See Website for Pricing						
.028 in / .71 mm	99243	99244	99245	99246	99247	99248
Weight Per Thousand (lbs)	.64	.81	.99	1.17	1.34	1.51
See Website for Pricing						
.030 in / .76 mm	99253	99254*	99255*	99256*	99257*	99258*
Weight Per Thousand (lbs)	.71	.90	1.15	1.32	1.52	1.71
See Website for Pricing						
.036 in / .92 mm	99263	99264	99265	99266	99267	99268
Weight Per Thousand (lbs)	1.04	1.31	1.67	1.87	2.15	2.54
See Website for Pricing						

Packaging: Bulk, 500 per bundle

Quantity Discounts (per type & length): 5M-9M less 5%, 10M-24M less 10%



WARNING: This product can expose you to chemicals including nickel and lead, which are known to the State of California to cause cancer and birth defects or other reproductive harm. For more information, visit www.P65Warnings.ca.gov



Wire Forms - Type B

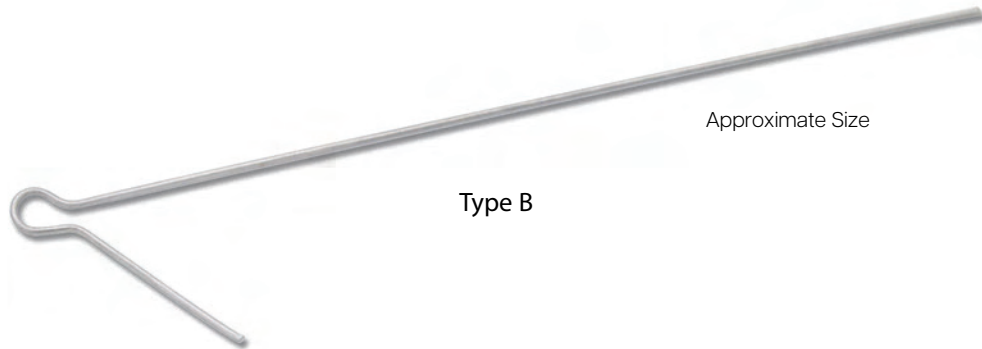

- Top-quality stainless steel for the finest in corrosion and rust protection, strength, and durability

Note: Special lengths available in 5,000 or greater quantities upon quotation.
Catalog numbers denoted by * are carried in stock.

Type B Stainless Steel Wire

Length	3"	4"	5"	6"	7"	8"
.020 in / .51 mm	--	--	99415	99416	99417	--
Weight Per Thousand (lbs)			.53	.62	.68	
See Website for Pricing						
.022 in / .56 mm	99423	99424	99425	99426	99427	99428
Weight Per Thousand (lbs)	.39	.50	.63	.74	.82	.93
See Website for Pricing						
.024 in / .61 mm	99433*	99434	99435	99436	99437	99438
Weight Per Thousand (lbs)	.48	.61	.76	.85	.98	1.11
See Website for Pricing						
.028 in / .71 mm	99443	99444	99445	99446	99447	99448
Weight Per Thousand (lbs)	.68	.88	1.03	1.20	1.38	1.53
See Website for Pricing						
.030 in / .76 mm	99453	99454*	99455*	99456*	99457*	99458*
Weight Per Thousand (lbs)	.81	1.01	1.23	1.42	1.63	1.83
See Website for Pricing						

Packaging: Bulk, 500 per bundle

Quantity Discounts (per type & length): 5M-9M less 5%, 10M-24M less 10%



WARNING: This product can expose you to chemicals including nickel and lead, which are known to the State of California to cause cancer and birth defects or other reproductive harm. For more information, visit www.P65Warnings.ca.gov



Industrial Wire Former

The Worth Industrial Wire Former is a commercial grade wire forming tool designed for the demanding requirements of the intermediate sized fishing lure manufacturer.

The wire former allows for great flexibility in creating a variety of wire shaft configurations such as end-eyelets, spring-lock shafts, buzz-bait forms, spinnerbait forms, jig spinners, center-shaft twists, and a variety of specialized kinks and bends. It provides for both wire bending and wire wrapping. The bending fixture features an adjustable wire stop and locator, adjustable base pin, and two rotating bending pins.

The wire wrapping fixture utilizes a positive wire-clamp feature and a rotating adjustable wrapping shaft. Both fixtures are positioned to allow the inclusion of lure components onto the wire shaft or eyelet being formed. All wear points are constructed of hardened tool steel for long life. Both rotating shafts are fitted with bronze bearings to reduce friction and wear.

The unit is constructed of machined aluminum. All forming pins and points are replaceable. The Wire Former is designed to be mounted or clamped to a workbench. Each unit includes pins and fixtures for the indicated range of wire diameters. Additional fixtures are available separately.

Weight Each: 2.45 lbs.

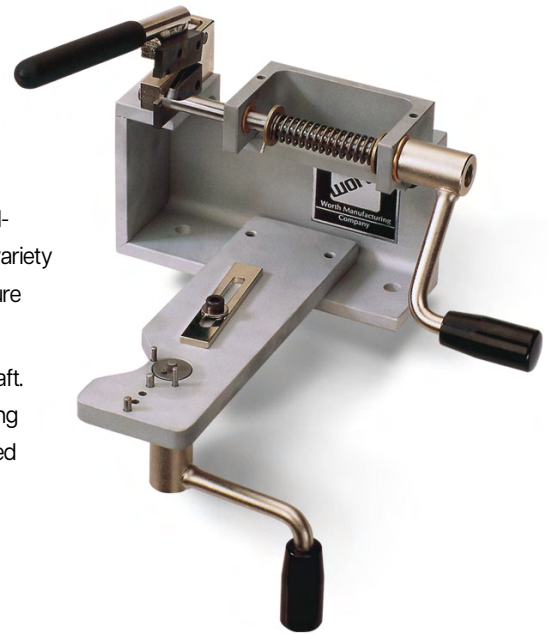

* Custom options available. Our wire former can be modified to suit most specialized needs. Contact our Sales team to learn more.

Industrial Wire Former

Unit	Industrial Wire Former	Pins & Fixtures Only	Upper Wrapping Unit	Lower Bending Unit
Wire Gauge Range	.018" - .024" / .46 mm - .61 mm diameter fixtures	.018" - .024" / .46 mm - .61 mm diameter wire - .095 eye	.018" - .024" / .46 mm - .61 mm diameter wire	.018" - .024" / .46 mm - .61 mm diameter wire
Catalog Number	94202	94206	94504	94572
See Website for Pricing				
Wire Gauge Range	.026" - .034" / .66 mm - .87 mm diameter fixtures	.026" - .034" / .66 mm - .87 mm diameter wire - .135 eye	.026" - .034" / .66 mm - .87 mm diameter wire	.026" - .034" / .66 mm - .87 mm diameter wire
Catalog Number	94203	94207	94503	94571
See Website for Pricing				
Wire Gauge Range	.035" - .045" / .89 mm - 1.15 mm diameter fixtures	.035" - .045" / .89 mm - 1.15 mm diameter wire - .170 eye	.035" - .045" / .89 mm - 1.15 mm diameter wire	.035" - .045" / .89 mm - 1.15 mm diameter wire
Catalog Number	94204	94208	94505	94570
See Website for Pricing				

Heavy Duty Industrial Wire Former

Unit	Industrial Wire Former	Pins & Fixtures Only	Upper Wrapping Unit	Lower Bending Unit
Wire Gauge Range	.051 in / 1.30 mm diameter fixtures	.051 in / 1.30 mm diameter wire - .187 eye	.051 in / 1.30 mm diameter wire	.051 in / 1.30 mm diameter wire
Catalog Number	94205	80014	94506	94573
See Website for Pricing				



WARNING: This product can expose you to chemicals including nickel and lead, which are known to the State of California to cause cancer and birth defects or other reproductive harm. For more information, visit www.P65Warnings.ca.gov



Wire Forming Tool



Our patented wire former enables the user to make all types of required bends, loops, and eyes in stainless or tinned music wire shafts. With its hardened steel guides and pins, this sturdy tool is excellent for short production runs or specialized operations for the lure manufacturer. It is also an excellent hobbyist's tool and is utilized in a variety of lure making kits. Uses .018-.024 wire.

Product Number	94201
Weight Each	.22 lbs
See Website for Pricing	

Quantity Discounts:

100 less 5%, 1,000 less 10%



WARNING: This product can expose you to chemicals including nickel and lead, which are known to the State of California to cause cancer and birth defects or other reproductive harm. For more information, visit www.P65Warnings.ca.gov



Fly Tying Vise



We offer this economical high-quality vise with the hobbyist in mind. This is the ideal vise for fly tying kits, fly tying classes, and quantity users who require a good but inexpensive vise. The jaw projects 4 1/2" from the table top giving ample room for winding hackle or thread. The sturdy 'C' clamp will accommodate tables up to 1 3/8" thick and mounts solidly. This vise has no rivets to break or cause repairs, and is carefully stamped from high-quality steel. Nickel-plated for rust resistance.

Product Number	94200
Weight Each	.18 lbs
See Website for Pricing	

Quantity Discounts:

100 less 5%, 1000 less 10%



WARNING: This product can expose you to chemicals including nickel and lead, which are known to the State of California to cause cancer and birth defects or other reproductive harm. For more information, visit www.P65Warnings.ca.gov



Split Ring Pliers



Industrial Split Ring Pliers

These high-quality pliers are designed to make short and effortless work of attaching split rings to articles and fasteners of all types. Constructed from strong forged steel with comfortable non-slip handle.

Includes instruction sheet.

Product Number	91500
Weight Each	.35 lbs
See Website for Pricing	

No Quantity Discounts

Fisherman's Split Ring Pliers

A great multi-use tool designed primarily for assembling small split rings, but may also be used for crimping leader sleeves or small sinkers. Attractively priced and perfect for light assembly operations or consumer resale. Made from bright zinc - plated steel.

Product Number	91501
Weight Each	.13 lbs
See Website for Pricing	

Quantity Discounts:

100 less 5%, 1000 less 10%



★ ★ ★ ★ ★
ASSEMBLY TIP
Keep Your Split Ring's Memory!

Proper split ring assembly is imperative, so don't compromise the memory. To accomplish this, keep the ring and the blade on the same plane as much as possible. Insert the blade between the two coils and spin the ring onto the blade, lifting the ring (changing the angle) only enough to aid the assembly. Always try and assemble the blade where the least distance is achieved between the hole and the edge of the blade.

 **WARNING:** This product can expose you to chemicals including nickel and lead, which are known to the State of California to cause cancer and birth defects or other reproductive harm. For more information, visit www.P65Warnings.ca.gov



Clamshells

Worth clamshells will accommodate most packaging needs for spoons, lures, or part applications. These are clear virgin PVC enclosures with a bottom hinge and snap closure. Packages can also be taped or stapled for extra security. Their transparency offers excellent product visibility for faster customer recognition.



Clamshells

Type	Small Spoon Single	Large Spoon Single	Large Flat Box with Cavity
Weight Per Thousand (lbs.)	8.31	13.0	16.93
Width (in.)	1.5	1.75	2.6875
Length (in.)	4.75	6.00	4.8125
Depth (in.)	1.00	1.00	.6875/cavity depth: .5
Catalog Number	91511	91510	91520
See Website for Pricing			

Packaging: Bulk, Boxed



WARNING: This product can expose you to chemicals including nickel and lead, which are known to the State of California to cause cancer and birth defects or other reproductive harm. For more information, visit www.P65Warnings.ca.gov



Clamshells



91515



91514



91512

Clamshells

Type	Small Box	Long Box	Deep Box
Weight Per Thousand (lbs.)	8.89	32.4	23.9
Width (in.)	1.5	2.6875	2.6875
Length (in.)	4.00	6.75	4.375
Depth (in.)	.50	.875	1.75
Catalog Number	91515	91514	91512
See Website for Pricing			

Packaging: Bulk, Boxed



WARNING: This product can expose you to chemicals including nickel and lead, which are known to the State of California to cause cancer and birth defects or other reproductive harm. For more information, visit www.P65Warnings.ca.gov

Custom Colors



Surface Finishes

As the leading lure components manufacturer in the world, we know that in order for you to be successful, your products must first catch your customer's eye before they catch any fish.

The Worth Company offers a wide range of best in class surface finishes including Bright Nickel & Zinc electroplate, Polished Brass & Stainless Steel, as well as a full line of Painted and Printed finishes.

We also realize that having a unique product separates you from your competitors. That's why rather than

offering common off-the-shelf stock painted patterns, we offer a full line of world-class finishes that are extremely durable and allow us to create any pattern and color combination under the sun.

By combining finishes we are able to create products that are truly unique to each customer while always meeting the high standards you expect from The Worth Company. By choosing The Worth Company for all your surface finishing needs, you'll catch exactly what you want, customers.

Infinite Enamel Colors

At The Worth Company we won't limit you to a handful of color choices. From the brightest white to the deepest black and every hue in between, whatever your project requires, we can match it!

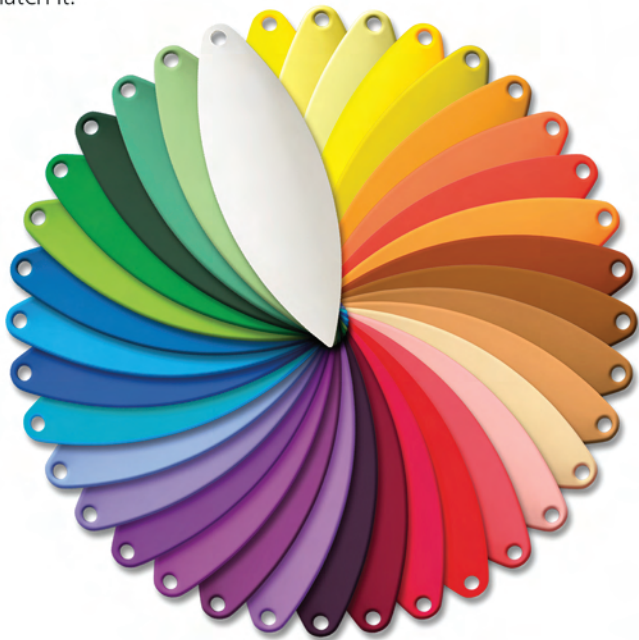

Endless combinations and treatments are possible with our glossy enamel colors.

Infinite Metallic Colors

Metallics give you the sheen and reflectiveness of nickel with the added appeal of color. We can turn almost any color into a metallic color. As with all of our paints, metallic colors work well when combined with additional artwork or a logo.



Feel free to use your imagination when it comes to metallics. It doesn't have to be a single color.



We can even simulate the look of copper, brass or black nickel on our nickeled blades.



WARNING: This product can expose you to chemicals including nickel and lead, which are known to the State of California to cause cancer and birth defects or other reproductive harm. For more information, visit www.P65Warnings.ca.gov

sales@worthco.com
www.worthco.com

Fluorescent Colors

Our fluorescent colors are pigment based paints with intense bright hues. Blades may be painted with a single color, a combination of colors, or with additional artwork added such as a company logo.



Fluorescent Orange



Fluorescent Green



Fluorescent Blue



Logo added to a Fluorescent Orange blade.



Chartreuse



Fluorescent Red



Fluorescent Pink



Graphic added to a Fluorescent 3-color fade.

Pearl

A sparkly white color. While beautiful alone Pearl also works extremely well when used as a base underneath additional artwork or a logo.



Pearl



Photographic image added to a Pearl blade.



Color and a graphic added to a Pearl blade.

UV Magic Clear Coat - *Now UV it, now U-Don't*

Science has confirmed what many anglers have known for years. Fish recognize and are attracted to Ultraviolet light. UV Magic Clear Coat is an ultra-durable, specially designed coating that reflects more UV light than ever before, causing lures to be even more irresistible to fish while working to boost anglers catch rates.



By combining traditional painting and advanced printing techniques with the most reflective UV coating available, we are able to produce designs that are completely unique and sure to catch your customer's eye.



WARNING: This product can expose you to chemicals including nickel and lead, which are known to the State of California to cause cancer and birth defects or other reproductive harm. For more information, visit www.P65Warnings.ca.gov

sales@worthco.com
www.worthco.com

Glow Colors

We are excited to offer a line of brilliantly glowing and durable glow paints. Our line of Nova Glow paint is the brightest and longest lasting glow paint in the industry. While our line of Cool Glow offers a wide range of colors with intense glowing characteristics to meet all your application needs. As with all of our paints, glow paints work well when combined with additional artwork or a logo.



Stock Fish Patterns

Our finishing catalog wouldn't be complete without a best-in-class line of photo realistic bait fish patterns. These popular bait fish are sure to be mistaken for the real thing. Combined with our durable gloss finish, you'll be sure to catch customers and fish alike.



WARNING: This product can expose you to chemicals including nickel and lead, which are known to the State of California to cause cancer and birth defects or other reproductive harm. For more information, visit www.P65Warnings.ca.gov

sales@worthco.com
www.worthco.com

Real Feel™

We are extremely proud to offer our **Real Feel™** blades and spoons. This technology gives us the ability to add amazing raised textures, patterns and designs to our high quality lure components. You have to feel it!

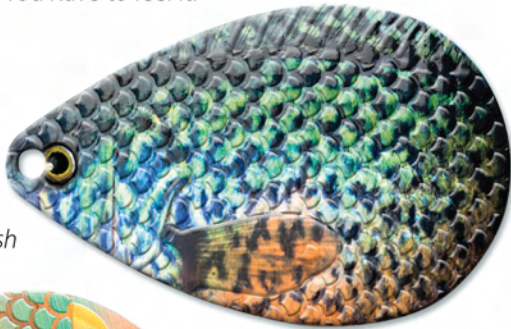

Add a scale pattern to a fish image.



Enhance a design or a logo.



Combine embossing with Fluorescent or Glow Colors.



Create a metal-stamped look on a polished blade.

Graphic Enhancement

With our high tech digital system you are no longer limited to one-color logos or simple graphics. Bring us your ideas and we will help bring them to life!

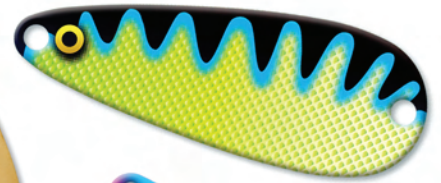

Company logos and custom designs are a breeze!



Photographic images are printed with amazing detail and true to life colors.



Two-sided colors and designs are not a problem.

Glitter

We also offer the option to add a glitter to nearly any color or color combinations, which is sure to catch both fish and attention. Shown here combined with black enamel and white enamel paint.



Polishing & Electroplating

The Worth Company has offered polished and plated components for over 75 years. A variety of corrosion resistant finishes are offered including the following...



Polished Brass



Polished Brass
Lacquered



Nickel



Gold



WARNING: This product can expose you to chemicals including nickel and lead, which are known to the State of California to cause cancer and birth defects or other reproductive harm. For more information, visit www.P65Warnings.ca.gov

sales@worthco.com
www.worthco.com



Custom Manufacturing



*Our fully equipped
factory in
Stevens Point, WI.*

It's easier and more affordable than you might think!

For over 70 years The Worth Company has been manufacturing Fishing Tackle Component parts. We have state-of-the-art equipment to help produce your product quickly and more efficiently. If you need help with a special design, heavier split ring, or an unusual wire form, we have a full-time lure component designer who can bring your custom parts to life.

Need dies for your special blade? Tooling for a wire form or split ring? We have an in-house, fully-staffed tool department that can make all the necessary tooling requirements for your part. All tooling is made in house here in Stevens Point, WI. We have done this so that when the tooling is completed it can be thoroughly tested in the press or 4-slide that it will be run on. With the tooling made in house, we know that it is being done correctly.

If you have been thinking about making that special part, either send us a drawing with dimensions or a sample part. After reviewing the item, if we have any questions, we will contact you before quoting. We all know it's better to have everything correct the first time and our goal is to surpass your expectations.

Need a special bend or twist on your wire form?

We have many different machines that can do this for you. Our equipment is able to handle many different types of material, like brass, steel or stainless steel and virtually any wire diameter.

We understand the complexities and requirements necessary to create wire forms to your exact requirements. Minimums can run from 5,000 to 25,000 parts depending on the machine that is being used. If these minimums are too high, please take a look at our Industrial Wire Former on page 105. This enables you to do all types of bends and twists in smaller quantities. If you send us your part, we will test it on the machine to make sure it comes out exactly as you want.

For custom made parts, please send us either a sample or drawing with dimensions and we will prepare a quote for you.

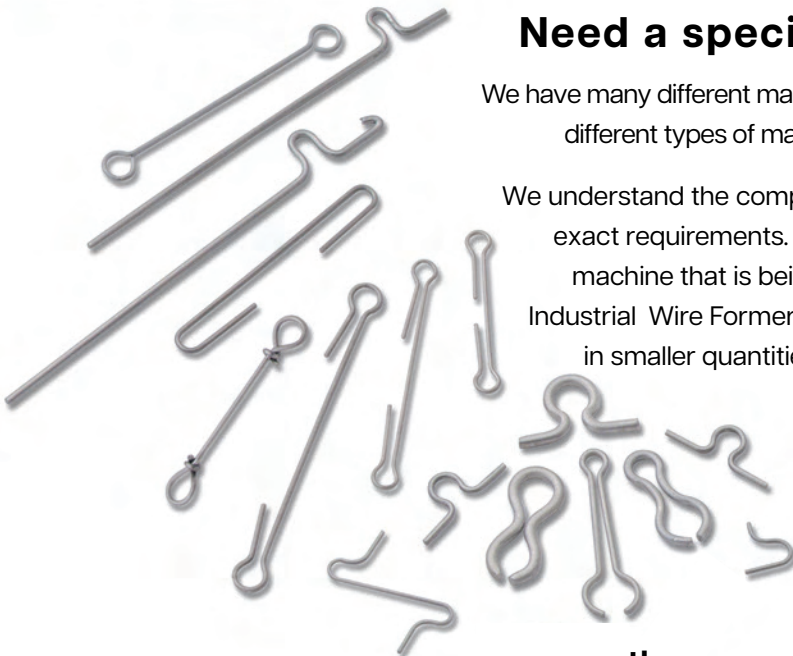



Custom Manufacturing

Looking for something special?

How could anyone require a split ring different from the hundreds we already offer? Easy. You may want a different shape, such as oval rather than round, or you might need a different wire diameter, outside diameter, or inside diameter.

We have an in-house Tool and Wire Department, so that for your special project we can usually have pre-production samples within 1 to 1-1/2 weeks.

We offer different types of material like brass, steel and stainless steel. We offer nickel and zinc plating in house.

To get a quote, please send us a sample or drawing with dimensions.

Remember, the split ring has a very important role with your lure and you should always demand the best.

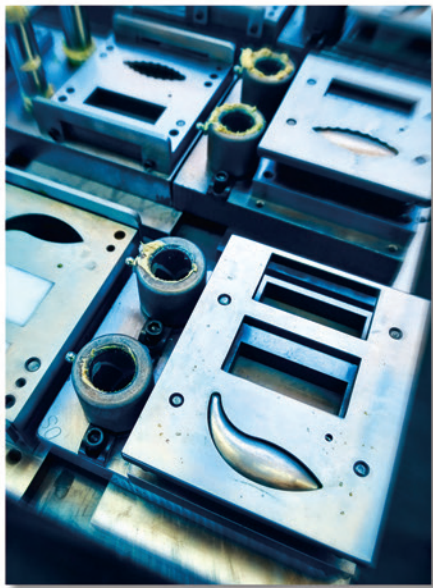
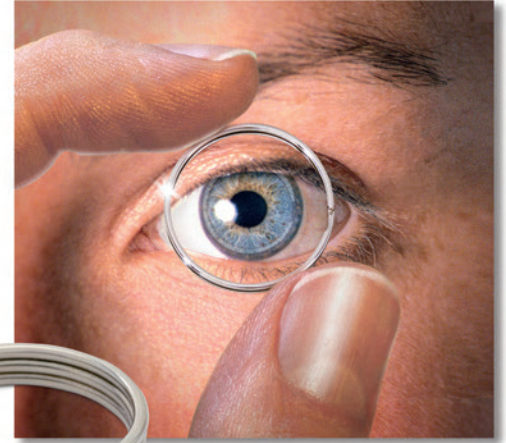

Custom Blade Stamping

Custom dies and stamps can be made for many different items. We can create imprint stamps to put your name, logo or design into the blade, or perhaps you like our Colorado or Willowleaf blades with a little different shape or cup. There's nothing out of the question.

If your shape is so completely different than anything we have, we can quote you on making a completely new die for your part.

Since we have an in-house Tool Department, we are able to get your die done in a timely manner. Parts are then tested and we will send you pre-production samples to make sure they meet your expectations. Once we start running the product, there are many checks that the part goes through before they are shipped to you. This way we make sure that you are receiving exactly what you requested.

With our state-of-the-art machinery and qualified staff, we are capable of making your unique part. All products are confidential and cannot be sold to anyone else without your permission.

If you have that unique part, please send us a drawing with dimensions or a sample and we will prepare a quote for you. It's affordable and can really make your lures distinctive.

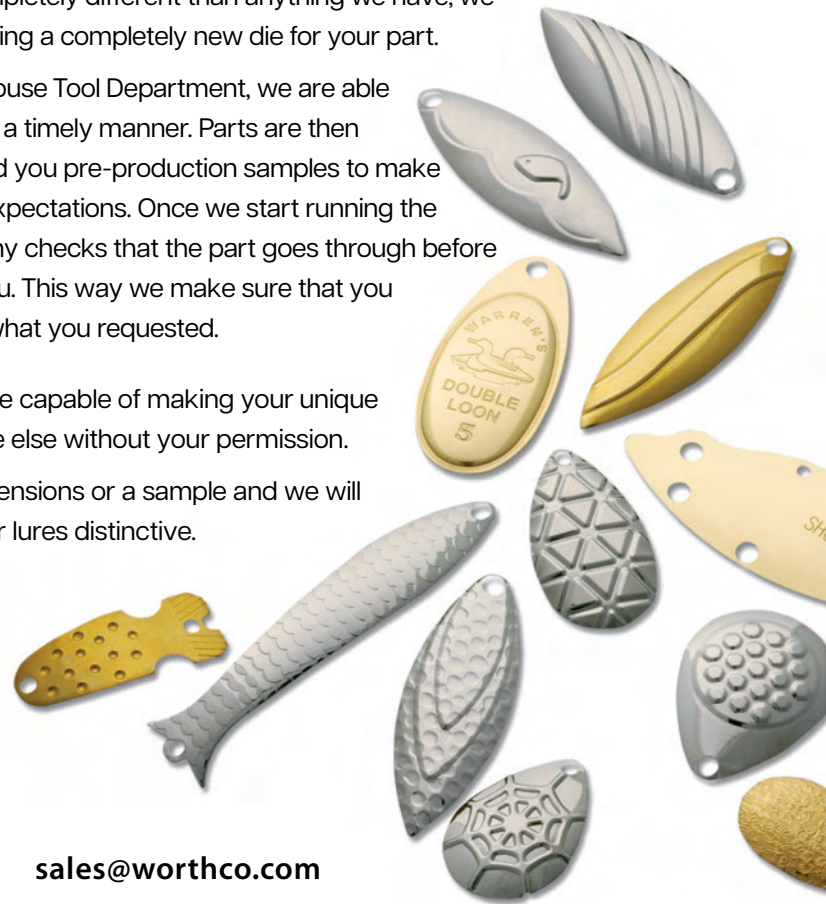



Terms & Information

TERMS: Net 30 days to all pre-approved accounts. Shipments are made F.O.B. Stevens Point, WI unless otherwise specified by the customer. Master Card, Discover, and VISA are also accepted for credit card payment. No past due customers will be shipped merchandise. Accounts are payable in U.S. funds only.

PRICES: Prices are subject to change without notice.

QUANTITY DISCOUNTS: Quantity discounts are allowed for each individual product, size and finish. No combination or further discounts are available.

FEDERAL EXCISE TAX: Federal Excise Tax applies to articles of sport fishing equipment that are designed or constructed for the use in the sport of fishing. Therefore, component items purchased from The Worth Company are subject to a 10% Federal Excise Tax. The manufacturer, producer or importer pays this tax. Exemption from this tax requires the customer to have an approved I.R.S. Form #637 on file with The Worth Company. This form can be obtained from your local I.R.S. office. The Federal Excise Tax paid by the manufacturers on the sale of sport fishing equipment goes directly into a fund dedicated specifically for projects to improve fishery habitat, fishery access and aquatic education. In addition, the funds have supported state fish hatchery and stocking programs, education efforts, weed control and habitat improvement projects and fishery research.

SALES & USE TAX: State Tax may be applicable based on the Nexus State orders are shipped to.

SAMPLES: Samples are available to qualified manufacturers upon request. For larger sample orders, there will be a fee of \$15 to \$25 plus freight. We will advise you of the fee when you place your request for samples. Please contact The Worth Company for sample request orders.

RETURNED GOODS: A minimum restocking charge of 10% will be made on any goods returned in their original condition. No returns are allowed on specials, painted items, polish brass lacquered items or gold products which are not regularly cataloged by us. No returns will be accepted without prior approval. Returns will not be accepted after 60 days from the invoice date.

EQUIPMENT PURCHASES: Equipment will require 100% pre-payment before any product can be shipped.

HANDLING CHARGE: For orders less than \$10, there is a \$2 handling charge.

MINIMUM ORDER QUANTITIES: All component products listed in our catalog have a Minimum Order Quantity of 100-pcs. Each line item under 100-pcs will be charged an additional small order fee of \$5.00. If your order total is \$100.00 or more when ordering less than the Minimum Order Quantity, the small order fee of \$5.00 per line item will be waived.

INSURED PACKAGES: All USPS packages are insured if the value is over \$100. All USPS Foreign/Canada shipments are insured regardless of their value. UPS Ground/Residential are insured if the value is \$500 or more. UPS Collect shipments are always insured. All Foreign/Canada shipments are insured regardless of their value.

SPECIAL ORDERS: Products of special design will require 100% pre-payment on all custom tooling charges, along with a signed purchase order. All quotations and tooling agreements must be signed and on file before a custom order can be implemented. A \$100 deposit is required on all custom components unless otherwise approved by Worth Management. Standard variance for special orders is +/- 10% of the original order quantity. Overages or shortages on orders requiring special material will be reviewed on an individual basis. All quotations, tooling agreements and deposit money must be signed and on file before any projects begin. The delivery time frame listed on each quotation will begin with the receipt of this documentation and all required deposit money. When applicable, any initial specification sheet submitted to the customer must be approved, signed and returned in order for the project to proceed. The Worth Company will cover the cost of the initial set-up and pre-production samples, subject to the required minimum quantities. This will include all metal component parts and wire forms. A response must be made within 24 hours from the receipt of the samples. Any delays beyond that 24-hour period will result in project delays and additional costs for rescheduling and 2nd set-up of the project tooling. The customer will be responsible for any "Next Day Air" charges if requested.

PATENTS: When placing an order for goods appearing within, the purchaser warrants that the finished article is not and will not be an infringement of any valid patents or trademarks, and the purchaser further agrees, at his own expense, to defend any and all actions and suits which may be brought against the company charging such infringement.

PACKAGING: All items contained within are shipped in bulk. Items are counted by weight and are guaranteed accurate within +/- 2%. Special quantity packaging is available for an additional cost, contact The Worth Company to get a quote.



P.O. Box 88
214 Sherman Avenue
Stevens Point , WI, USA, 54481

1-800-944-1899
715-344-6081

sales@worthco.com

www.worthco.com

